



ROYAL CANADIAN AIR CADETS
PROFICIENCY LEVEL FOUR
INSTRUCTIONAL GUIDE



SECTION 1

EO M431.01 – EXPLAIN FEATURES OF WING DESIGN

Total Time: 30 min

PREPARATION

PRE-LESSON INSTRUCTIONS

Resources needed for the delivery of this lesson are listed in the lesson specification located in A-CR-CCP-804/PG-001, *Proficiency Level Four Qualification Standard and Plan*, Chapter 4. Specific uses for said resources are identified throughout the instructional guide within the TP for which they are required.

Review the lesson content and become familiar with the material prior to delivering the lesson.

Obtain a model of a light fixed-wing aircraft with wing struts, fixed gear and control surface detail.

Prepare slides of the figures located at Attachment A.

Obtain a model of a wing.

PRE-LESSON ASSIGNMENT

Nil.

APPROACH

An interactive lecture was chosen for this lesson to clarify, emphasize, and summarize features of wing design.

INTRODUCTION

REVIEW

Nil.

OBJECTIVES

By the end of this lesson the cadet shall be expected to explain features of wing design.

IMPORTANCE

It is important for cadets to be able to explain features of wing design as it directly relates to the production of lift by the wing. Being able to explain features of wing design provides knowledge for potential instructional duties and is part of the fundamentals that cadets pursuing future aviation training will require.



Use the model aircraft with articulated control surfaces and flaps throughout this lesson to illustrate features of wing design as they are discussed.

Teaching Point 1

Explain airfoils.

Time: 10 min

Method: Interactive Lecture

AIRFOILS

Chord. An imaginary straight line joining the leading and trailing edges of the wing. The mean aerodynamic chord (MAC) is the average chord of the wing.

The shape and design of the wing is directly influenced by the intended purpose of the aircraft. Aircraft designed to fly slowly typically have thick airfoils, while aircraft designed to fly fast have thin airfoils.



Show the slide of Figure A-1 to the cadets.

The very thin layer of air lying over the surface of the wing is called the boundary layer. At the front of the wing, the boundary layer flows smoothly over the surface and this area is called the laminar layer. As the air flows further along the wing, it slows down due to skin friction, the layer becomes thicker, and it becomes turbulent. The turbulent area is called the turbulent layer.

The transition point between the laminar and turbulent areas tends to move forward as airspeed and the angle of attack increase.

Conventional Airfoils

Conventional airfoils generally are the thickest at 25 percent of the chord and can be found in a variety of shapes and designs.



Show the slide of Figure A-2 to the cadets and describe the different airfoil shapes.

Laminar Flow Airfoils



Show the slide of Figure A-3 to the cadets and show the differences between conventional and laminar flow airfoil shapes.

Laminar flow airfoils have their thickest point at 50 percent of the chord, a leading edge that is more pointed and upper and lower surfaces that are nearly symmetrical. Originally developed to make aircraft fly faster, they can be found on many different aircraft types.



The design of the laminar flow airfoil reduces drag by maintaining the laminar flow of air throughout a greater percentage of the chord. The pressure distribution is more even, but the transition point moves forward more rapidly near the point of stall.

Planform



Show the slide of Figure A-4 to the cadets.

The shape of the wing as seen from directly above is called the planform. The three general wing shapes are:

- rectangular,
- elliptical (rounded), and
- delta (swept).

Aspect ratio. The relationship between the length of the wing and its width (chord). It is calculated by dividing the span by the average chord.

A wing with a high aspect ratio generates more lift with less induced drag than a wing with the same wing area and a low aspect ratio. High aspect ratio wings are commonly found on gliders.

Angle of Incidence



Show the slide of Figure A-5 to the cadets.

The angle of incidence is the angle at which the wing is permanently inclined to the longitudinal axis of the aircraft.

The angle of incidence affects the following items:

- flight visibility,
- takeoff and landing characteristics, and
- amount of drag in level flight.

Wash-Out and Wash-In

To reduce the tendency of the wing to stall suddenly, the wing can be designed so that the angle of incidence at the wing tip is different than the angle of incidence at the wing root.



Show the slide of Figure A-6 to the cadets.

The twist in the wing causes the tip and root to stall at slightly different angles of attack and improves the stall characteristics. If the wing root stalls before the wing tip, the ailerons, located closer to the wing tip, can still be effective during the early part of the stall.

Decreasing the angle of incidence at the wing tip is called wash-out and increasing the angle is called wash-in.

CONFIRMATION OF TEACHING POINT 1

QUESTIONS:

- Q1. What happens to the transition point as airspeed and angle of attack increase?
- Q2. What is the aspect ratio of a wing?
- Q3. What is it called when the angle of incidence at the wing tip is decreased?

ANTICIPATED ANSWERS:

- A1. The transition point moves forward.
- A2. The relationship between the length of the wing and its width (chord). It is computed by dividing the span by the average chord.
- A3. Wash-out.

Teaching Point 2

Explain high-lift devices.

Time: 10 min

Method: Interactive Lecture

HIGH-LIFT DEVICES

The efficiency of a wing can be improved by either increasing the amount of lift generated, or by decreasing the amount of induced drag created. High-lift devices can be used individually or in various combinations to create a very efficient wing.

Although great gains in efficiency can be realized by adding these devices to a wing, there are penalties to pay, such as increased weight and increased mechanical complexity.

Wing Tip Design

Induced drag can be reduced by limiting the formation of wing tip vortices. This is done by preventing air from spilling over the wing tip by modifying the wing tips in one of the following ways:

- installing wing tip fuel tanks,
- using wing tip plates or winglets, and
- drooping the wing tips.



Show Figures A-7 and A-8 to the cadets.

Wing Fences



Show the slide of Figure A-9 to the cadets. Wing fences can also be seen in Figure A-8.

Wing fences are vertical surfaces attached to the upper surface of the wing. They act as guides and control the direction of airflow over the wing, especially at high angles of attack. This improves low-speed handling and stall characteristics.

Slats



Show the slide of Figure A-10 to the cadets.

Auxiliary airfoils that automatically move out in front of the leading edge at high angles of attack are known as slats. The resulting opening changes the airflow over the leading edge, smoothing out eddies that form on the top of the wing.

Slots



Show the slide of Figure A-11 to the cadets. Slots can also be seen in Figure A-10.

Slots affect the airflow in the same way as slats, except that they are passageways built into the wing. Slots can either be full- or partial-span.



Slats are moving devices. Slots are built into the wing and do not move.

Flaps

The most common high-lift device found on a wing is the flap. Located at the trailing edge, their primary purpose is to increase lift by changing the camber of the wing. Some styles of flaps also increase the effective wing area. The increased lift causes a lower stall speed and allows the aircraft to approach at a slower airspeed.



Show the slide of Figure A-12 to the cadets.

With a small amount of flap deflection, the amount of extra lift produced is greater than the amount of extra drag. As the amount of deflection increases, the amount of extra drag catches up to and passes the amount of extra lift being generated. The extra drag produced can be used to improve landing capabilities by slowing the aircraft down and creating a steeper approach angle (useful in approaching a runway with obstacles near the threshold).



Show the slide of Figure A-13 to the cadets.

Generally, the amount of drag produced by flaps reduces acceleration to the point where flaps should not be deployed during takeoff (as is the case with plain and split flaps). Slotted, Zap, and Fowler flaps produce more lift than drag at small amounts of deflection (5–15 degrees) and are usually recommended for takeoff.



In some aircraft, landing with full flaps and a crosswind is not recommended as the flaps may disrupt the airflow over the tail surfaces and make it difficult to control the aircraft during the ground roll.

CONFIRMATION OF TEACHING POINT 2

QUESTIONS:

- Q1. How can induced drag be reduced by wing tip design?
- Q2. What is the main difference between slats and slots?
- Q3. What do flaps increase?

ANTICIPATED ANSWERS:

- A1. Induced drag can be reduced by:
 - installing wing tip fuel tanks,
 - using wing tip plates or winglets, and
 - drooping the wing tips.
- A2. Slats are moving devices. Slots are built into the wing and do not move.
- A3. Flaps increase lift and drag. They may also increase the effective wing area.

Teaching Point 3**Explain spoilers and speed brakes.**

Time: 5 min

Method: Interactive Lecture



Show the slide of Figure A-14 to the cadets.

SPOILERS

Spoilers are devices on a wing that are used to decrease the lift and increase the drag being produced. They work by being extended up from the top surface of the wing and disrupting the airflow. Spoilers are found on almost all types of gliders and are used to increase the rate of descent during the landing approach.

Spoilers can also be used to supplement aileron control or replace ailerons completely. A deployed spoiler has the same effect as an up-going aileron, causing the aircraft to bank to that side.

SPEED BRAKES

Speed (dive) brakes are devices that are extended into the airflow, creating drag, with minimal effect on the lift being produced. Speed brakes allow aircraft to slow down without reducing thrust, and to control approach angles.

Speed brakes may be plates that extend out of a wing or hinged doors that open out from the fuselage.



Most gliders have speed brakes that extend out of the bottom of the wing.

CONFIRMATION OF TEACHING POINT 3**QUESTIONS:**

- Q1. Where are spoilers located?
- Q2. What control surface can spoilers supplement or replace?
- Q3. What do speed brakes create?

ANTICIPATED ANSWERS:

- A1. On the top surface of a wing.
- A2. Ailerons.
- A3. Drag.

END OF LESSON CONFIRMATION

QUESTIONS:

- Q1. What is the chord?
- Q2. How can adding devices negatively affect a wing?
- Q3. What do spoilers increase during the landing approach of most gliders?

ANTICIPATED ANSWERS:

- A1. An imaginary straight line joining the leading and trailing edges of the wing.
- A2. They create increased weight and mechanical complexity.
- A3. The rate of descent.

CONCLUSION

HOMEWORK / READING / PRACTICE

Nil.

METHOD OF EVALUATION

This EO is assessed IAW A-CRR-CCP-804/PG-001, *Proficiency Level Four Qualification Standard and Plan*, Chapter 3, Annex B, Aviation Subjects–Combined Assessment PC.

CLOSING STATEMENT

Understanding wing design, the features that improve the efficiency of the wing and devices that produce drag to control the approach angle provides knowledge for potential instructional duties and is part of the fundamentals that cadets pursuing future aviation training will require.

INSTRUCTOR NOTES / REMARKS

Cadets who are qualified Advanced Aviation may assist with this instruction.

REFERENCES

C3-116 ISBN 0-9680390-5-7 MacDonald, A. F., & Pepler, I. L. (2000). *From the ground up: Millennium edition*. Ottawa, ON: Aviation Publishers Co. Limited.

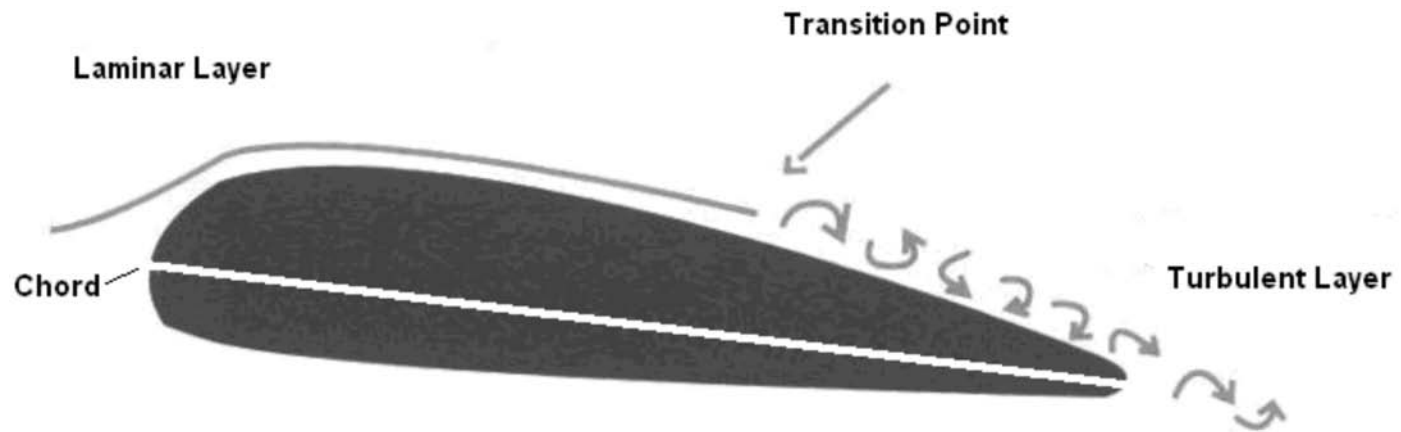

Figure A-1 Laminar and Turbulent Layers

Note. From *From the Ground Up: Millennium Edition* (p. 25), by A. F. MacDonald and I. L. Pepler, 2000, Ottawa, ON: Aviation Publishers Co. Limited. Copyright 2000 by Aviation Publishers Co. Limited.

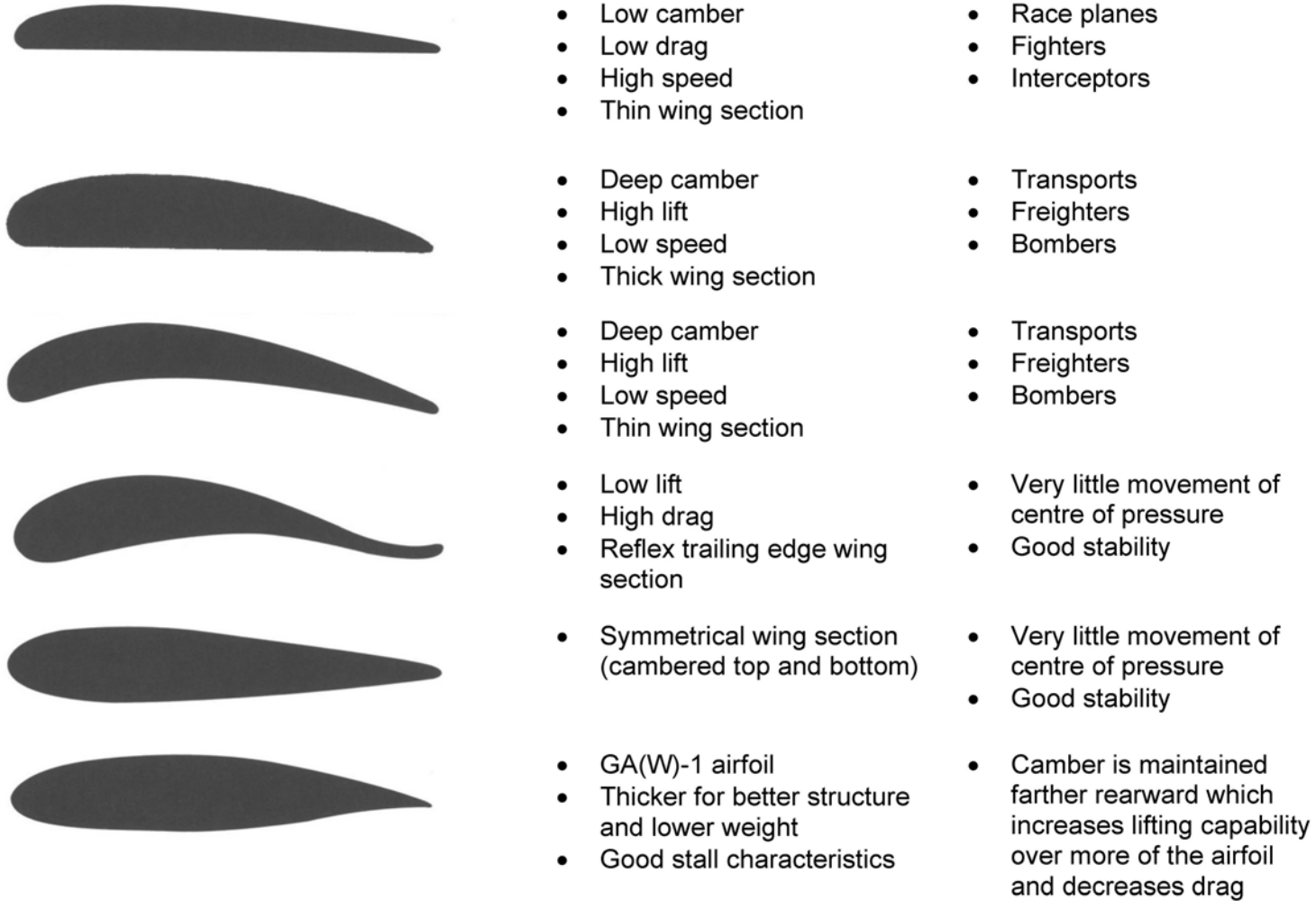

Figure A-2 Airfoil Sections

Note. From *From the Ground Up: Millennium Edition* (p. 26), by A. F. MacDonald and I. L. Peppler, 2000, Ottawa, ON: Aviation Publishers Co. Limited. Copyright 2000 by Aviation Publishers Co. Limited.

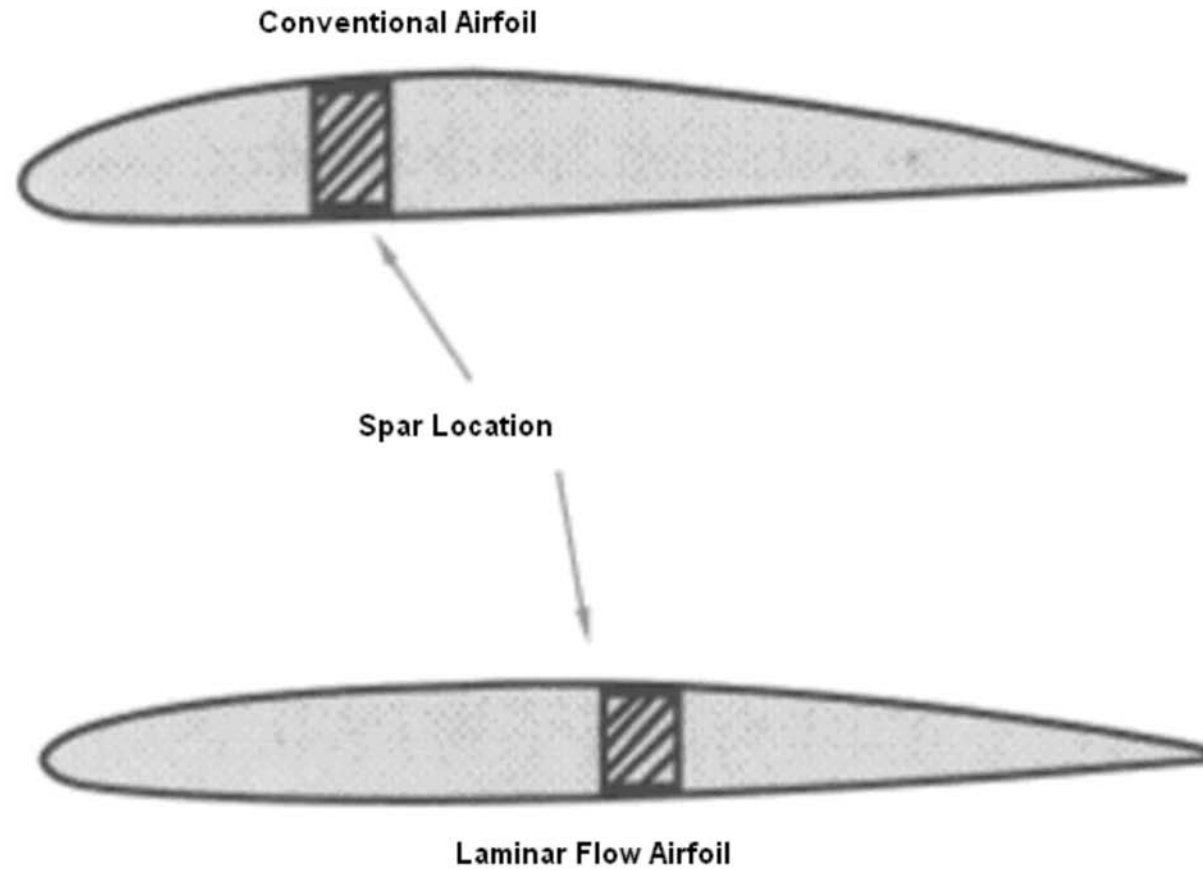

Figure A-3 Conventional and Laminar Flow Airfoils

Note. From From the Ground Up: Millennium Edition (p. 27), by A. F. MacDonald and I. L. Pepler, 2000, Ottawa, ON: Aviation Publishers Co. Limited. Copyright 2000 by Aviation Publishers Co. Limited.

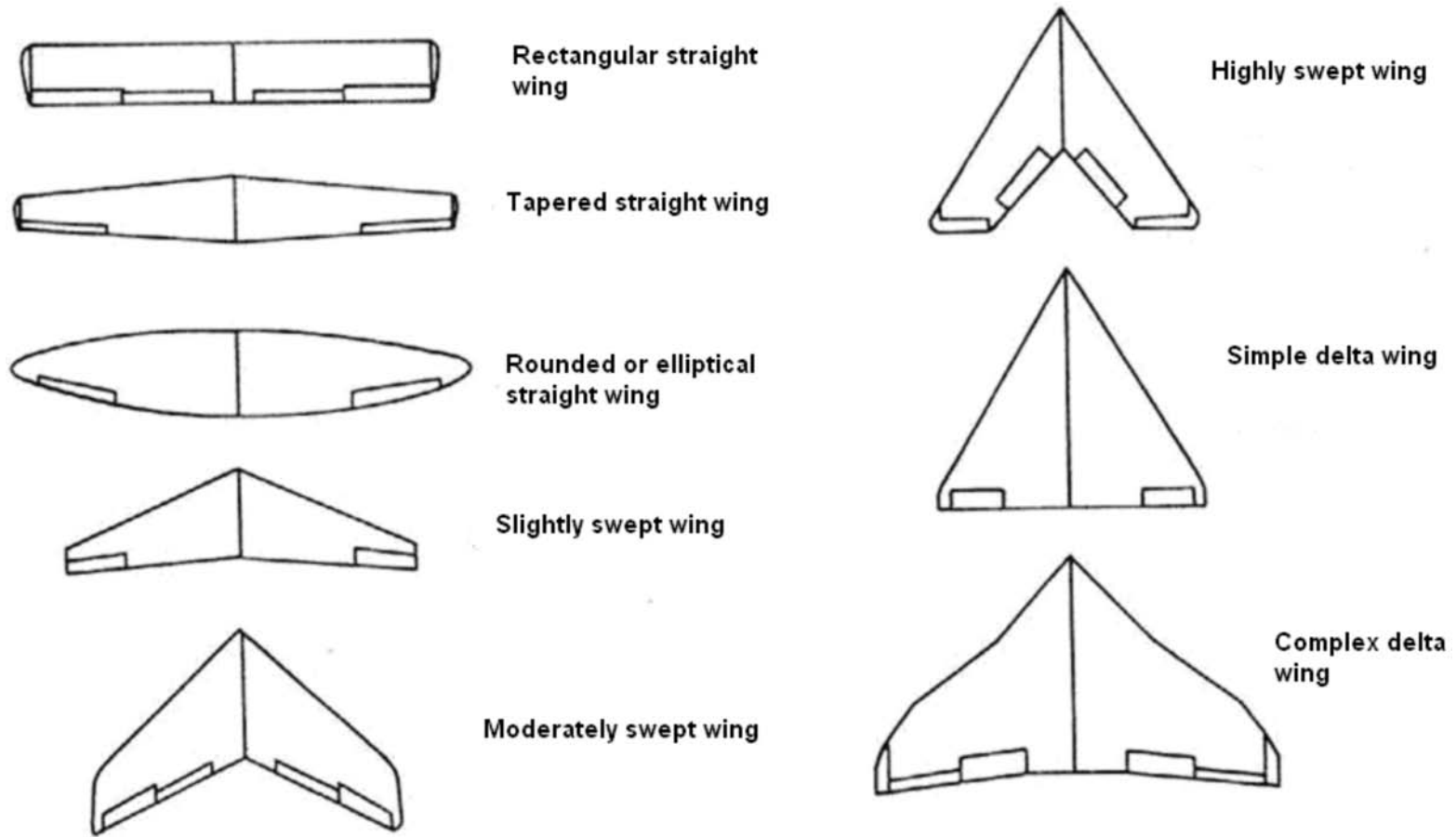

Figure A-4 Examples of Wing Planforms

Note. From "SP-367 Introduction to the Aerodynamics of Flight", NASA. Retrieved October 22, 2008, from <http://history.nasa.gov/SP-367/f13b.htm>

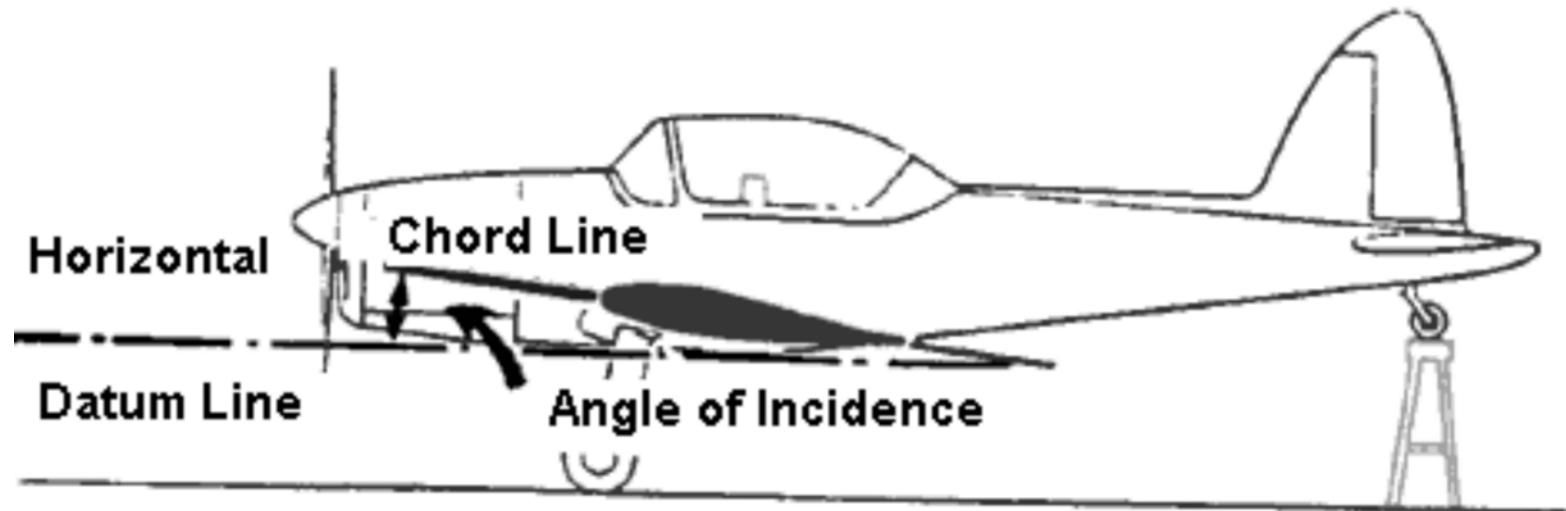

Figure A-5 Angle of Incidence

Note. From *From the Ground Up: Millennium Edition* (p. 27), by A. F. MacDonald and I. L. Pepler, 2000, Ottawa, ON: Aviation Publishers Co. Limited. Copyright 2000 by Aviation Publishers Co. Limited.

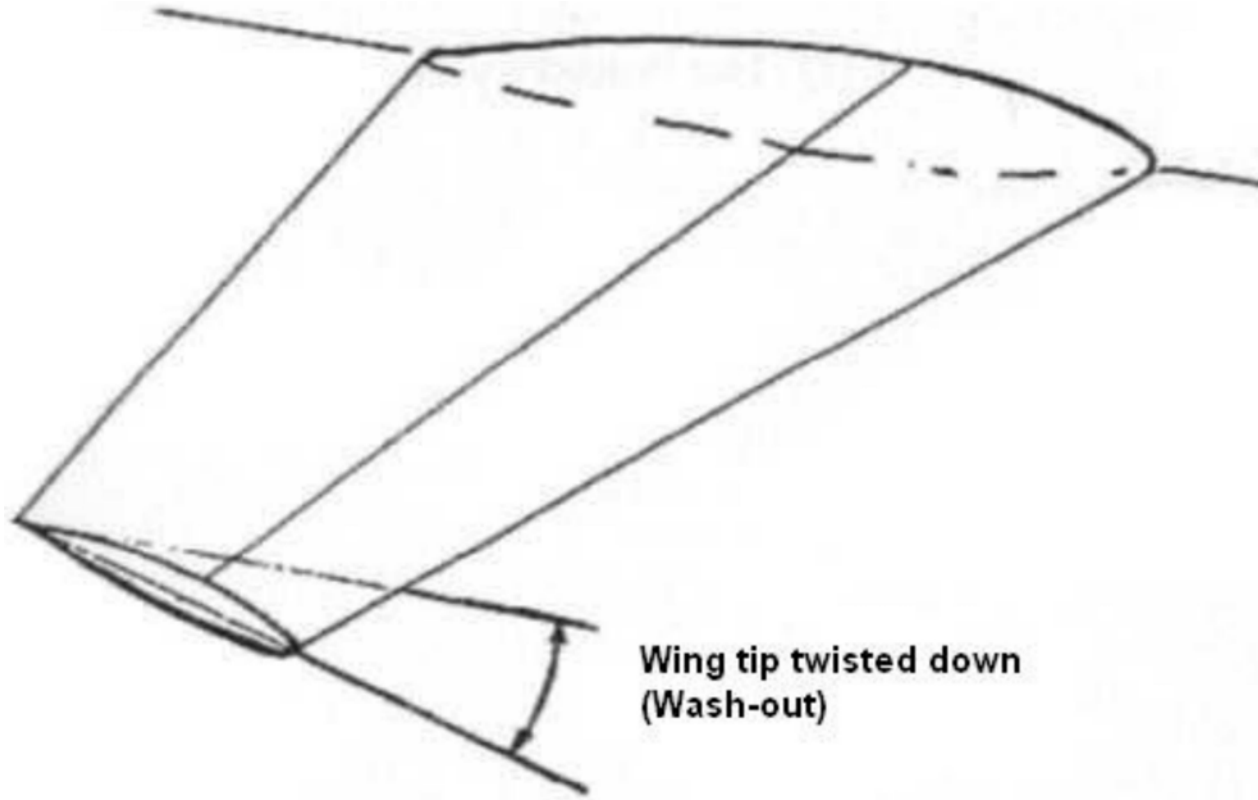

Figure A-6 Wash-Out

Note. From "Wing Twist and Dihedral", 2001, *Aerospaceweb.org*. Retrieved October 22, 2008, from <http://www.aerospaceweb.org/question/dynamics/q0055.shtml>



Figure A-7 Wing Tip Tanks and Winglets

Note. From "Canada's Air Force, Image Gallery, Details", 2006, *Department of National Defence*, Copyright 2006 by Department of National Defence. Retrieved October 22, 2008, from http://www.airforceimagery.forces.gc.ca/netpub/server.np?find&catalog=casimages&template=detail2_e.np&field=itemid&op=matches&value=4461&site=casimages



Figure A-8 Drooping the Wing Tips

Note. From "Cessna 170", 2008, *Barnstormers.com*. Retrieved October 22, 2008, from http://www.barnstormers.com/listing_images.php?id=266438&ZOOM=%2Fclassified_files%2F266438-DSC04234.jpg



Figure A-9 Wing Fences

Note. From "STOL Kit", *F. and H. (Aircraft)*. Retrieved October 22, 2008, from http://www.fandh-aircraft.co.uk/stol_kit.htm

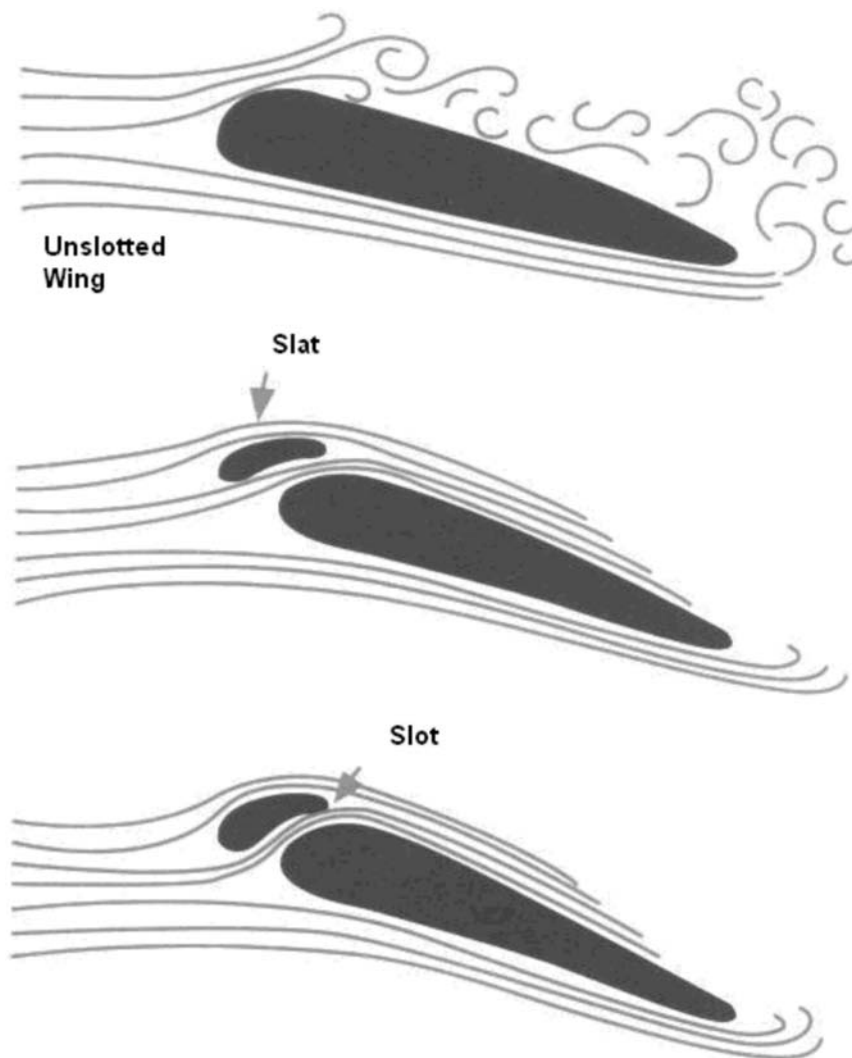

Figure A-10 Slotted Wings

Note. From *From the Ground Up: Millennium Edition* (p. 28), by A. F. MacDonald and I. L. Pepler, 2000, Ottawa, ON: Aviation Publishers Co. Limited. Copyright 2000 by Aviation Publishers Co. Limited.



Figure A-11 Leading Edge Slot

Note. From "Stinson 108", 2005, *Wikipedia*. Retrieved October 22, 2008, from <http://en.wikipedia.org/wiki/Image:Stinson108-3photo03.jpg>

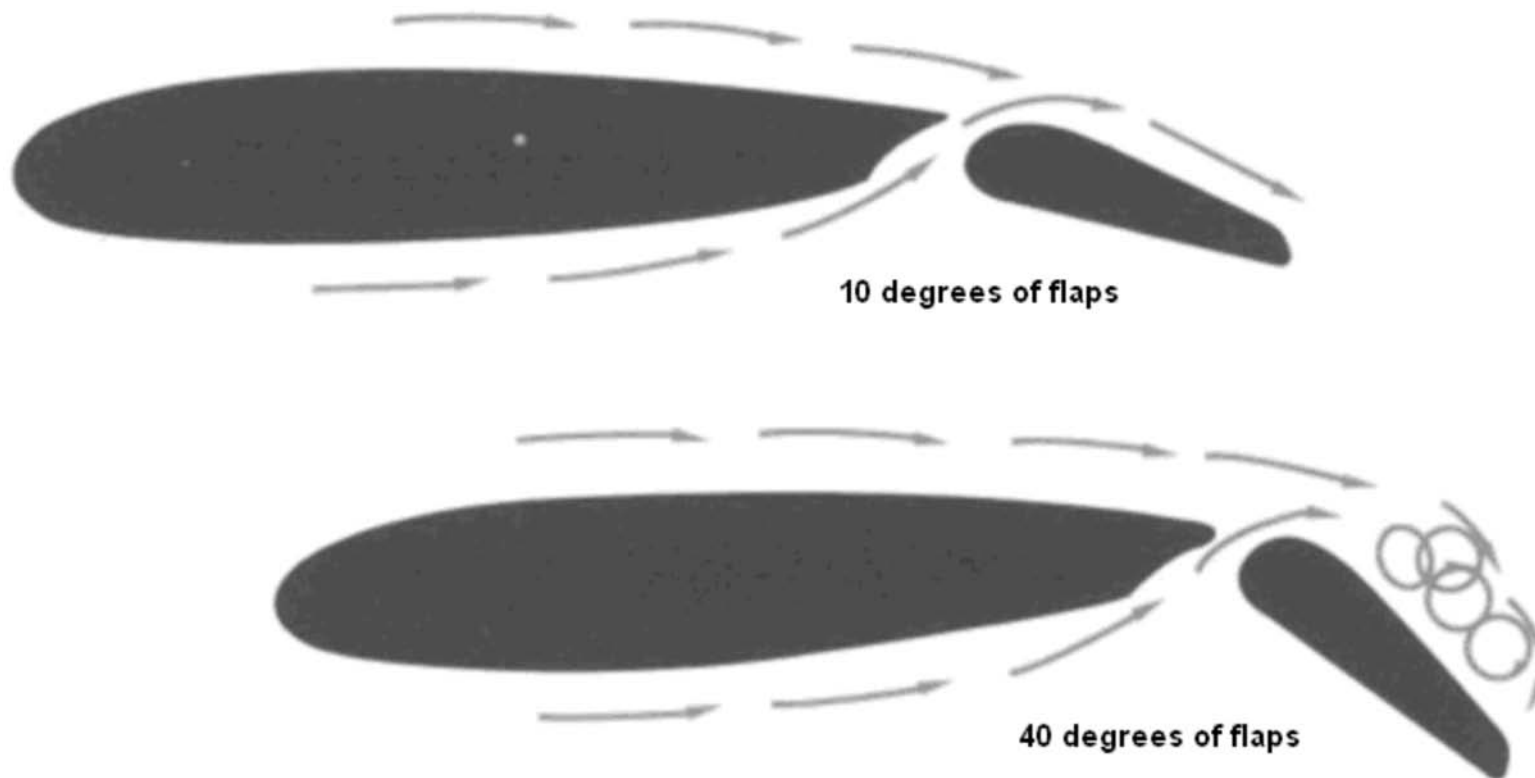

Figure A-12 Flap Settings

Note. From *From the Ground Up: Millennium Edition* (p. 29), by A. F. MacDonald and I. L. Pepler, 2000, Ottawa, ON: Aviation Publishers Co. Limited. Copyright 2000 by Aviation Publishers Co. Limited.

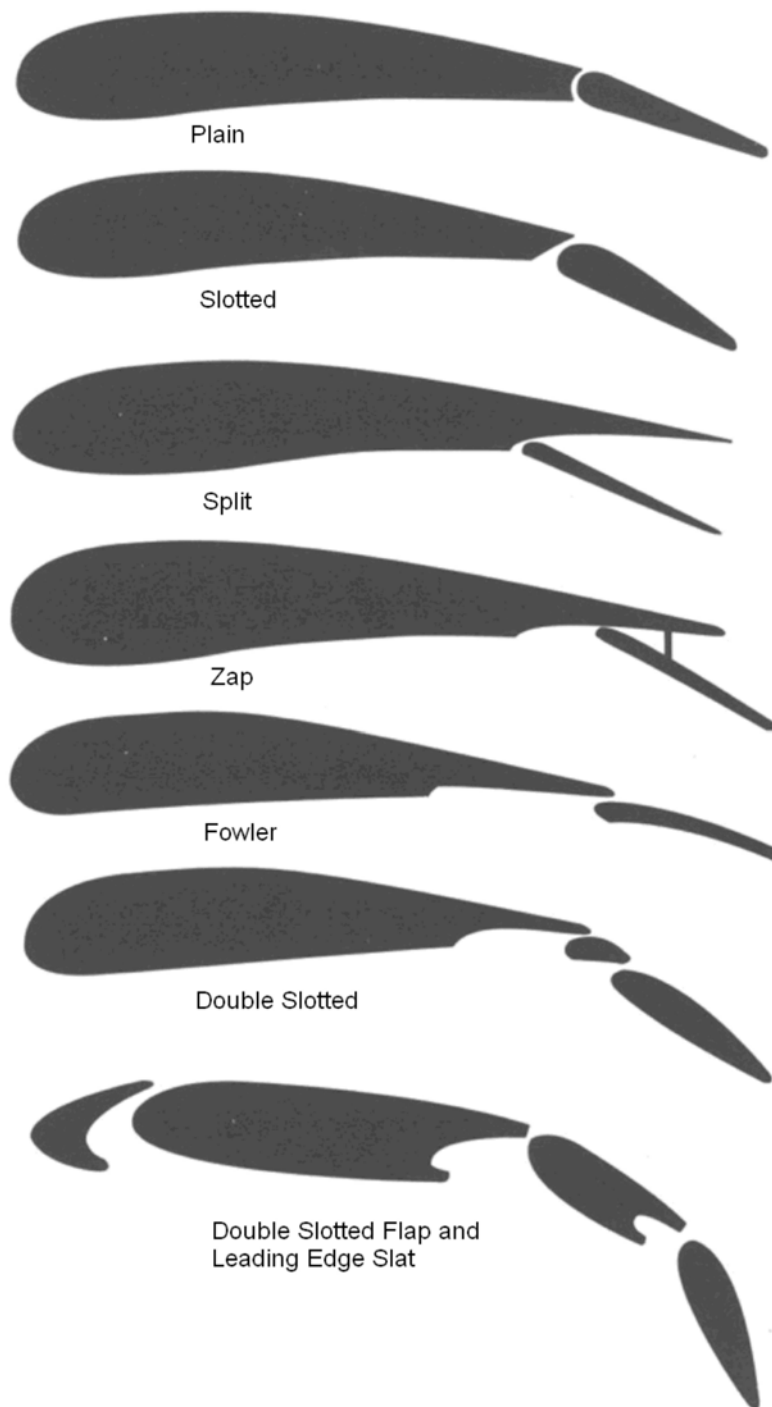

Figure A-13 Flaps

Note. From *From the Ground Up: Millennium Edition* (p. 29), by A. F. MacDonald and I. L. Pepler, 2000, Ottawa, ON: Aviation Publishers Co. Limited. Copyright 2000 by Aviation Publishers Co. Limited.

Spoilers and Dive Brakes Closed



Spoilers and Dive Brakes Open

Figure A-14 Spoilers and Dive Brakes

Note. From *Air Cadet Gliding Program Manual* (p. 6-3-2), 2008, Ottawa, ON: Department of National Defence.



ROYAL CANADIAN AIR CADETS
PROFICIENCY LEVEL FOUR
INSTRUCTIONAL GUIDE



SECTION 2

EO M431.02 – DESCRIBE FLIGHT INSTRUMENTS

Total Time:	60 min
-------------	--------

PREPARATION

PRE-LESSON INSTRUCTIONS

Resources needed for the delivery of this lesson are listed in the lesson specification located in A-CR-CCP-804/PG-001, *Proficiency Level Four Qualification Standard and Plan*, Chapter 4. Specific uses for said resources are identified throughout the instructional guide within the TP for which they are required.

Review the lesson content and become familiar with the material prior to delivering the lesson.

Photocopy Attachment A for each cadet.

Prepare slides of the figures located at Attachment A.

Obtain a gyroscope for use in TP2.

Construct a working model of each of the pitot static instruments IAW Attachment C.

PRE-LESSON ASSIGNMENT

Nil.

APPROACH

An interactive lecture was chosen for this lesson to clarify, emphasize and summarize flight instruments.

INTRODUCTION

REVIEW

Nil.

OBJECTIVES

By the end of this lesson the cadet shall be expected to describe flight instruments.

IMPORTANCE

It is important for cadets to be able to describe flight instruments as they are the basic instruments used during flight. Being able to describe flight instruments provides knowledge for potential instructional duties and is part of the fundamentals that cadets pursuing future aviation training will require.

Teaching Point 1**Review the pitot static system and pitot static instruments.**

Time: 25 min

Method: Interactive Lecture

PITOT STATIC SYSTEM

Instruments connected to the pitot static system work on air pressure. There are two types of air pressure in the pitot static system:

- pitot pressure, and
- static pressure.

Pitot pressure. The increase in air pressure caused by the forward motion of the aircraft through the air.

Static pressure. The atmospheric pressure outside the aircraft, not affected by turbulence or motion.



Show the slide of Figure A-1 to the cadets.

The airspeed indicator (ASI) is connected to both the pitot pressure source (usually a tube attached to the nose or wing) and the static pressure port(s) (usually a small vent on the side of the aircraft). The altimeter and the vertical speed indicator (VSI) are connected only to the static pressure port.

Both the pitot tube and static pressure ports should be carefully checked during the walk-around inspection prior to flight to ensure they are not blocked. A blockage will cause an instrument to provide an incorrect reading. During flight, it is possible for the pitot tube to become blocked by ice. Aircraft that are designed to be flown under instrument flight rules (IFR) will have a pitot heater to prevent ice buildup in the pitot tube.

AIRSPEED INDICATOR (ASI)

The ASI is connected to both the pitot pressure source and static pressure port(s) and displays the difference between the two pressures as the speed of the aircraft moving through the air (not over the ground).

ASI Markings

The ASI has colour-coded markings to indicate operating ranges and speeds.



Show the slide of Figure A-2 to the cadets.

Red. A red line indicates the never exceed speed (V_{NE}).

Yellow. A yellow arc starts at the maximum structural cruise (V_{NO}) and extends to the V_{NE} . This area is typically known as the caution range.

Green. The normal operating range. It starts at the power-off stalling speed (V_{SL}) and extends to the V_{NO} .

White. The range in which fully extended flaps may be used. It starts at the power-off stalling speed with flaps and gear extended (V_{SO}) and extends to the maximum flaps extended speed (V_{FE}).

ASI Errors

Density error. The ASI is calibrated for normal sea level pressure of 29.92 inches of mercury (Hg) at a temperature of 15 degrees Celsius. Temperature and pressure normally decrease with an increase in altitude, decreasing the density of the air and causing the ASI to read less than the true airspeed.

Position error. Results from the position of the pitot pressure source. Eddies formed by air moving over the aircraft and the angle of the pitot source to the airflow cause position error.

Lag error. A mechanical error that is the result of friction between the working parts of the instrument. This error is responsible for a slight delay between a change in airspeed occurring and the change being shown on the instrument.

Icing error. The error caused by a complete or partial blockage of the pitot pressure by ice. This error can be prevented or corrected by turning on the pitot heat (if equipped) or descending to a lower altitude where the outside air temperature (OAT) is higher.

Water error. Water in the system can cause higher or lower than normal readings and may block the system completely. Water can be kept out of the system by covering the pitot source when the aircraft is parked. This will also keep dirt and insects from entering the system.

Airspeed Definitions

Indicated airspeed (IAS). The uncorrected airspeed read from the instrument dial.

Calibrated airspeed (CAS). The IAS corrected for instrument (lag) error and installation (position) error.

Equivalent airspeed (EAS). The CAS corrected for the compressibility factor. This is very significant to aircraft operating above 10 000 feet and 250 knots (kt).

True airspeed (TAS). The CAS (or EAS) corrected for density (pressure and temperature).

ALTIMETER

The altimeter is connected only to the static pressure port(s) and measures the pressure of the outside air. A sealed aneroid capsule inside the instrument case expands or contracts due to changes in the static pressure. The expansion or contraction is mechanically linked to the indicator's needles and causes them to rotate around the dial to show the altitude.



Show the slide of Figure A-3 to the cadets.

Altimeter Errors

Pressure error. Barometric pressure varies from place to place and this error is corrected by using an altimeter setting obtained from the nearest aviation facility (flight service station, control tower, etc). All aircraft flying in the same area should be using the same altimeter setting.



"From high to low—look out below".

When an aircraft flies into an area with a relatively lower pressure, if the altimeter setting is not corrected, the altimeter will read higher than the actual altitude. For example, the altimeter may be indicating 4 000 feet, while the actual altitude may be

3 000 feet. This could cause a conflict with other aircraft, or even worse, cause the aircraft to come into contact with the ground.

Abnormally high pressure. Cold, dry air masses are capable of producing barometric pressures in excess of 31.00 inches of Hg (the limit of the altimeter setting scale in most altimeters). In this case, the actual altitude will be higher than the altitude indicated on the altimeter.

Abnormally cold temperature. Altimeters are calibrated for the standard atmosphere (15 degrees Celsius at sea level) and any deviation from that will cause an error. Extremely low temperatures may cause as much as 20 percent error in the altimeter, causing the altimeter to read higher than the actual altitude.

Mountain effect error. Increased wind speed through mountain passes or in mountain waves may cause a localized area of low pressure. Temperatures may also be affected, compounding the altimeter error.

Altitude Definitions

Indicated altitude. The altitude displayed on the altimeter when it is set to the current barometric pressure.

Pressure altitude. The altitude displayed on the altimeter when it is set to the standard barometric pressure (29.92 inches of Hg).

Density altitude. The pressure altitude corrected for temperature.

Absolute altitude. The actual height above the Earth's surface (the altimeter set to field level pressure).

VERTICAL SPEED INDICATOR (VSI)

The VSI is connected only to the static pressure port(s). The rate of change of the static pressure is transmitted to the needle to indicate if the altitude is increasing or decreasing.



Show the slide of Figure A-4 to the cadets.

Even though the VSI will quickly indicate a climb or descent, it may take several seconds before the correct rate of descent is displayed. This delay is known as lag. An instantaneous VSI has a complicated system of pistons and cylinders instead of the simpler aneroid capsule found in most VSIs and does not experience lag.

ACTIVITY

Time: 10 min

OBJECTIVE

The objective of this activity is to have the cadets practice reading pitot static instruments.

RESOURCES

- One working model of each of the pitot static instruments, including:
 - ASI,
 - altimeter, and
 - VSI; and
- Questions located at Attachment B.

ACTIVITY LAYOUT

Nil.

ACTIVITY INSTRUCTIONS

1. Divide the cadets into two groups.
2. Set one model at a time (in no particular order) and allow each group five seconds to read the instrument.
3. Have one group read the instrument to the class. The group gets one point for a correct answer.
4. If a group cannot correctly read the instrument then the other group can steal the point.
5. Repeat Steps 2–4 for the remaining time.
6. Declare the group with the most points the winner.

SAFETY

Nil.

CONFIRMATION OF TEACHING POINT 1

The cadets' participation in the activity will serve as the confirmation of this TP.

Teaching Point 2

Describe the gyroscope and gyroscopic instruments.

Time: 15 min

Method: Interactive Lecture

THE GYROSCOPE

The gyroscope is a spinning wheel (rotor) in a universal mounting (gimbal) that allows its axle to be pointed in any direction.



Show the slide of Figure A-5 to the cadets.

Gyroscopic Inertia

Also known as rigidity in space, gyroscopic inertia is the tendency of a rotating object to remain in its plane of rotation. This allows the spinning rotor to remain in place regardless of how the gimbal is moved around it.

Precession

Precession is the tendency of a rotating body, when a force is applied perpendicular to its plane of rotation, to turn in the direction of its rotation 90 degrees to its axis and take up a new plane of rotation parallel to the force applied.



Demonstrate gyroscopic inertia and precession to the cadets using a gyroscope.

Power Sources

To work properly the rotor must be kept spinning at a constant speed. The gyroscopic instruments may be powered by one or more power source.

Engine driven vacuum system. A vacuum pump powered by the engine. It does not work if the engine is not running (eg, prior to startup, following an engine failure). A variation of this system is an engine driven air pump that uses positive air pressure to spin the rotor.

Venturi driven vacuum system. A venturi tube on the outside of the aircraft creates a vacuum to spin the rotor. Simple to install, it has no moving parts that could fail, but depends on the airspeed of the aircraft and the tube causes additional drag.

Electrically driven gyroscopes. The rotor is spun by an electric motor allowing the gyroscope to work at high altitudes where vacuum systems are ineffective.

Care of Gyroscopic Instruments

Gyroscopic instruments are precision instruments and need to be cared for properly to prevent premature failure and damage. The air used to spin the rotor (vacuum or positive pressure) must be filtered to prevent dust and dirt from contaminating the system. The instruments need to be handled gently during installation and removal. Some gyroscopes must also be locked (caged) prior to aerobatics. Venturi driven systems are also susceptible to ice blockages.

HEADING INDICATOR (HI)



Show the slide of Figure A-6 to the cadets.

The HI (directional gyro [DG]) is steady and accurate as it is not afflicted with any of the errors that apply to magnetic compasses (eg, northerly turning error, acceleration and deceleration errors). It remains constant without swinging or oscillating and provides accurate readings even in rough air.



The cadets will learn about the magnetic compass in more detail in EO M437.02 (Describe the Magnetic Compass).

Vacuum driven HIs may take up to five minutes for the rotor to reach operating speed and should not be used during this period. Venturi driven HIs can not be used while taxiing or during takeoff. Once the rotor is spinning at the correct speed, the HI needs to be set to the current heading (by referencing the magnetic compass or runway heading).

Friction in the gyroscope causes a small amount of precession and will cause the reading to drift approximately three degrees over a period of 15 minutes. It is also subject to apparent precession. The rotation of the Earth gives the gyroscope an apparent motion relative to the Earth. This error varies with latitude. Apparent precession is zero at the equator and 15 degrees per hour at the poles.

Precession errors are easily corrected by resetting the HI to the current heading (by referencing the magnetic compass during straight and level flight) every 15 minutes.

ATTITUDE INDICATOR (AI)



Show the slide of Figure A-7 to the cadets.

The AI (artificial horizon or gyro horizon) is designed to provide an artificial horizon for the pilot during periods of poor visibility (eg, fog, clouds, rain, snow). The artificial horizon provides attitude information to the pilot (pitch and bank).

During acceleration or deceleration, precession will cause a slight indication of a climb or descent, respectively.

TURN AND SLIP INDICATOR



Show the slide of Figure A-8 to the cadets.

The turn and slip indicator (turn and bank) is a combination of two instruments and is also known as the needle and ball. The direction and rate of turn is indicated by the needle. The needle is controlled by a gyroscope. The ball is controlled by gravity. During a properly executed turn, centripetal and centrifugal forces are balanced with gravity and the ball stays in the centre. During a slipping turn there is not enough centrifugal force and the gravity will pull the ball in the direction of the turn. During a skidding turn there is not enough centripetal force and the ball is pulled in the opposite direction of the turn.



The turn and slip indicator does not indicate the amount of bank of the aircraft. It indicates the rate of turn and if the aircraft is skidding or slipping in the turn.

During a standard rate (rate one) turn, the aircraft turns at a rate of three degrees per second (360 degrees in two minutes).

The turn and slip indicator will also indicate if a wing is low during straight flight. If the needle is centred but the ball is not, then the wing on the side that the ball has moved to is low.

TURN CO-ORDINATOR



Show the slide of Figure A-9 to the cadets.

The turn co-ordinator is an updated version of the turn and slip indicator and is able to display the rate of roll as well as the rate of turn.

CONFIRMATION OF TEACHING POINT 2

QUESTIONS:

- Q1. What is gyroscopic inertia?
- Q2. What errors affect the HI?
- Q3. Which gyroscopic instrument can display the rate of roll as well as the rate of turn?

ANTICIPATED ANSWERS:

- A1. Gyroscopic inertia is the tendency of a rotating object to remain in its plane of rotation.
- A2. Precession and apparent precession.
- A3. The turn co-ordinator.

Teaching Point 3

Describe the angle of attack (AOA) indicator.

Time: 5 min

Method: Interactive Lecture

ANGLE OF ATTACK (AOA) INDICATOR



Show the slide of Figure A-10 to the cadets.

An aircraft will stall at different airspeeds depending on factors such as weight, load factor, and configuration. A stall will occur if the critical angle of attack is exceeded. The AOA indicator displays the relationship between the chord line of the wing and the relative airflow. Many indicators also have colour-coded ranges to alert the pilot that the critical AOA is being approached.

CONFIRMATION OF TEACHING POINT 3

QUESTIONS:

- Q1. What does the AOA indicator display?

ANTICIPATED ANSWERS:

- A1. The AOA indicator displays the relationship between the chord line of the wing and the relative airflow.

Teaching Point 4**Describe the Mach indicator.**

Time: 5 min

Method: Interactive Lecture

MACH INDICATOR

Show the slide of Figure A-11 to the cadets.

The Mach indicator displays the ratio of its airspeed to the local speed of sound. The Mach number is calculated by dividing the airspeed by the speed of sound. A Mach number of one means that the aircraft is travelling at the speed of sound. The Mach indicator measures and correlates static and dynamic pressures.



Distribute the handouts of flight instruments located at Attachment A to each cadet.

CONFIRMATION OF TEACHING POINT 4**QUESTIONS:**

Q1. How is the Mach number calculated?

ANTICIPATED ANSWERS:

A1. The Mach number is calculated by dividing the airspeed by the speed of sound.

END OF LESSON CONFIRMATION**QUESTIONS:**

Q1. What is density altitude?

Q2. How long does it take to complete a standard rate 360-degree turn?

Q3. How does the Mach indicator work?

ANTICIPATED ANSWERS:

A1. The pressure altitude corrected for temperature.

A2. Two minutes.

A3. The Mach indicator works by measuring and correlating static and dynamic pressures.

CONCLUSION

HOMEWORK / READING / PRACTICE

Nil.

METHOD OF EVALUATION

This EO will be assessed IAW A-CR-CCP-804/PG-001, *Proficiency Level Four Qualification Standard and Plan*, Chapter 3, Annex B, Aviation Subjects–Combined Assessment PC.

CLOSING STATEMENT

Future aviation training and instructional duties require knowledge of pitot static instruments, gyroscopes and gyroscopic instruments.

INSTRUCTOR NOTES / REMARKS

Cadets who are qualified Advanced Aviation may assist with this instruction.

REFERENCES

C3-116 ISBN 0-9680390-5-7 MacDonald, A. F., & Pepler, I. L. (2000). *From the ground up: Millennium edition*. Ottawa, ON: Aviation Publishers Co. Limited.

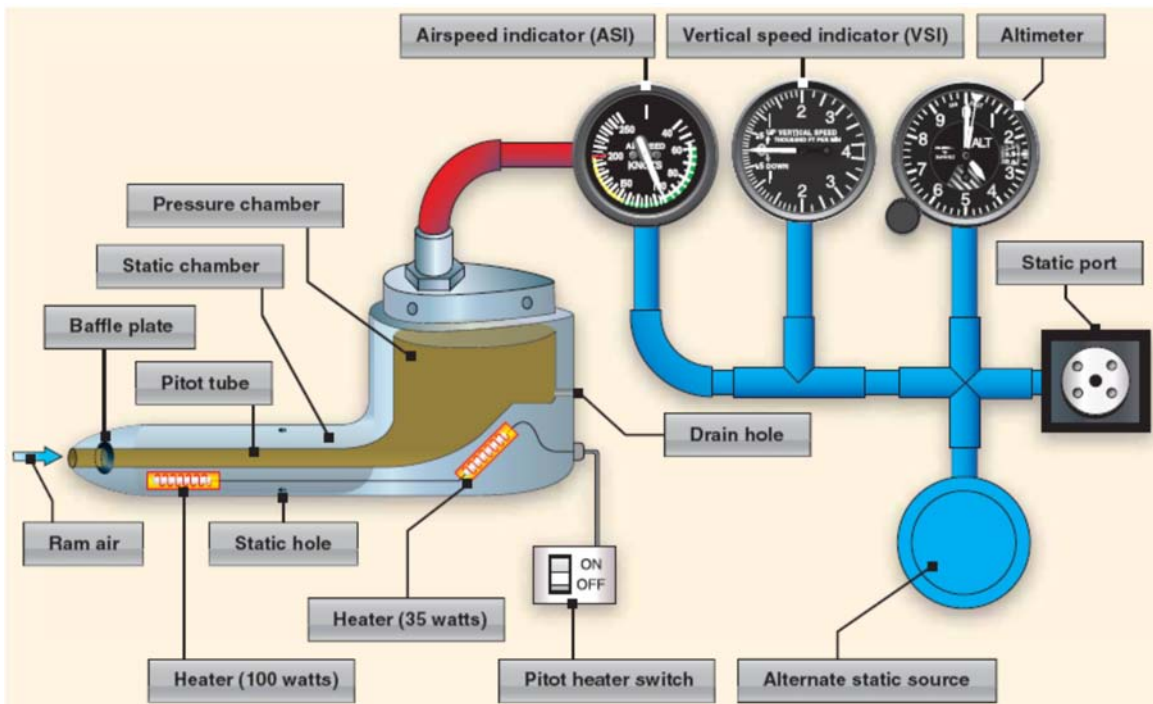

Figure A-1 Pitot Static System

Note. From "Pilot's Handbook of Aeronautical Knowledge", *Federal Aviation Administration*. Retrieved November 19, 2008, from <http://www.faa.gov/library/manuals/aviation/media/FAA-H-8083-25A.pdf>



Figure A-2 Airspeed Indicator

Note. From "Flight Instruments", *North American Powered Parachute Federation*. Retrieved October 30, 2007, from http://www.nappf.com/nappf_flight_instruments.htm



Figure A-3 Altimeter

Note. From "Flight Instruments", North American Powered Parachute Federation.
Retrieved October 30, 2007, from http://www.nappf.com/nappf_flight_instruments.htm



Figure A-4 Vertical Speed Indicator

Note. From "Flight Instruments", North American Powered Parachute Federation.
Retrieved October 30, 2007, from http://www.nappf.com/nappf_flight_instruments.htm

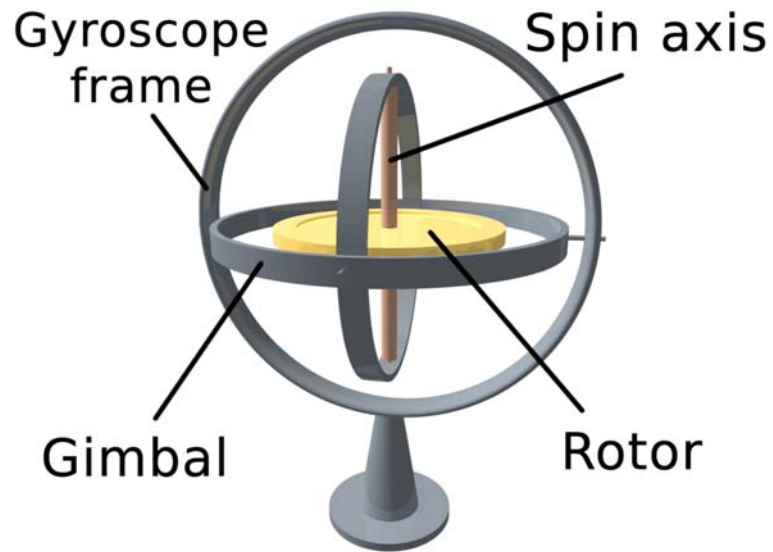

Figure A-5 Gyroscope

Note. From "3D Gyroscope", *Wikimedia*. Retrieved November 18, 2008, from http://upload.wikimedia.org/wikipedia/commons/e/e2/3D_Gyroscope.png

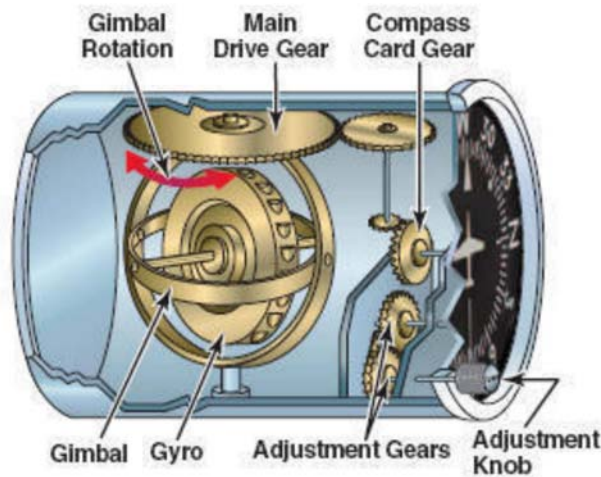

Figure A-6 Heading Indicator

Note. From "The Journal for the Proficient Pilot", *Over the Airwaves*. Retrieved November 18, 2008, from <http://overtheairwaves.com/vol3-46.jpg>

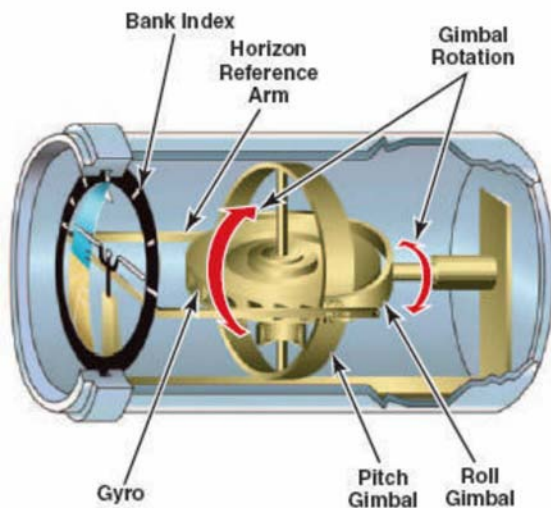

Figure A-7 Attitude Indicator

Note. From "The Journal for the Proficient Pilot", *Over the Airwaves*.
Retrieved November 18, 2008, from <http://overtheairwaves.com/vol3-45.jpg>



Figure A-8 Turn and Bank Indicator

Note. From "Turn and Bank Indicator", *Integrated Publishing*. Retrieved November 18, 2008, from http://www.tpub.com/content/aviation/14014/img/14014_164_2.jpg



Figure A-9 Turn Co-ordinator

Note. From "More Instruments", *Wings and Wheels*. Retrieved November 18, 2008, from <http://www.wingsandwheels.com/images/turn%20coordinator.gif>



Figure A-10 AOA Indicator

Note. From "Stall/Spin", *AOPA Online*. Retrieved November 18, 2008, from http://www.aopa.org/images/asf/tn_spin_9.jpg



Figure A-11 Mach Indicator

Note. From "Mach Airspeed Indicator (MASI)", *Innovative Solutions and Support*. Retrieved November 18, 2008, <http://www.innovative-ss.com/media/images/masi2.gif>

THIS PAGE INTENTIONALLY LEFT BLANK

SAMPLE QUESTIONS

Set the specific training aid to the desired reading. Allow a team to provide an answer. Use a different instrument for each question.

ASI Questions

For each question, set the ASI training aid to the desired value. These can be asked in any order.

125 kt
65 kt
40 kt
75 kt
180 kt
210 kt
98 kt
110 kt
55 kt

Altimeter Questions

For each question, set the altimeter training aid to the desired value. These can be asked in any order.

8 900 feet
1 300 feet
2 600 feet
11 000 feet
1 250 feet
600 feet
400 feet
300 feet
1 000 feet

VSI Questions

For each question, set the VSI training aid to the desired value. These can be asked in any order.

+200 feet per minute
+300 feet per minute
+150 feet per minute
+500 feet per minute
+800 feet per minute
-1000 feet per minute
-250 feet per minute
-900 feet per minute
-1200 feet per minute

THIS PAGE INTENTIONALLY LEFT BLANK

INSTRUCTIONS FOR CREATION OF PITOT STATIC INSTRUCTIONAL AIDS

Resources

- One sheet of bristol board per training aid,
- One brass Acco fastener per training aid,
- Pencil,
- Compass from a geometry set,
- Ruler or straight edge,
- Coloured markers, and
- White bristol board.

Instructions – ASI

1. Draw a representation of an ASI in the centre of the bristol board. Include all of the numbers and coloured arcs / lines. Use Figure A-2 as a guide.
2. Colour the arcs and lines with the appropriate colours (white arc, green arc, yellow arc and red line).
3. Cut out a dial hand from the white bristol board.
4. Attach the dial hand to the centre of the ASI using the brass Acco fastener.
5. Ensure that the hand can move when needed, but that there is enough friction to keep it from moving on its own.

Instructions – Altimeter

1. Draw a representation of an altimeter's face in the centre of the bristol board. Include all of the numbers and graduated lines between the numbers. Use Figure A-3 as a guide.
2. Colour the altimeter. To add variety of colour, use yellow and black for the polygon shape under the hands' pivot point.
3. Cut dial hands from the white bristol board to represent the hands of an altimeter.
4. Attach the hands to the centre of the altimeter using the brass Acco fastener.
5. Ensure that the hands can move when needed, but that there is enough friction to keep them from moving on their own.

Instructions – VSI

1. Draw a representation of a VSI in the centre of the bristol board. Include all of the numbers on the positive and negative scales. Ensure that zero is located on the left side. Use Figure A-4 as a guide.
2. Colour the VSI.
3. Cut out a dial hand from the white bristol board.
4. Attach the hand to the centre of the VSI using the brass Acco fastener.
5. Ensure that the hand can move when needed, but that there is enough friction to keep it from moving on its own.

THIS PAGE INTENTIONALLY LEFT BLANK



ROYAL CANADIAN AIR CADETS
PROFICIENCY LEVEL FOUR
INSTRUCTIONAL GUIDE



SECTION 3

EO C431.01 – EXPLAIN FLIGHT PERFORMANCE FACTORS

Total Time:	60 min
-------------	--------

PREPARATION

PRE-LESSON INSTRUCTIONS

Resources needed for the delivery of this lesson are listed in the lesson specification located in A-CR-CCP-804/PG-001, *Proficiency Level Four Qualification Standard and Plan*, Chapter 4. Specific uses for said resources are identified throughout the instructional guide within the TP for which they are required.

Review the lesson content and become familiar with the material prior to delivering the lesson.

Prepare handouts for each cadet and slides of the figures located at Attachment A.

Obtain a model aircraft with articulated control surfaces and flaps for use in TPs 1–5.

PRE-LESSON ASSIGNMENT

Nil.

APPROACH

An interactive lecture was chosen for this lesson to clarify, emphasize and summarize flight performance factors.

INTRODUCTION

REVIEW

Nil.

OBJECTIVES

By the end of this lesson the cadet shall be expected to explain flight performance factors.

IMPORTANCE

It is important for cadets to be able to explain flight performance factors as they apply to all stages of flight. Being able to explain flight performance factors provides knowledge for potential instructional duties and is part of the fundamentals that cadets pursuing future aviation training will require.



Use the model aircraft with articulated control surfaces and flaps throughout this lesson to illustrate flight performance factors as they are discussed.



Provide a handout of the figures to each cadet located at Attachment A.

Teaching Point 1

Explain left turning tendencies.

Time: 15 min

Method: Interactive Lecture

LEFT TURNING TENDENCIES

Most airplane engines turn the propeller in a clockwise direction (as seen from the pilot's seat). As a result of four different factors, this produces a tendency for the airplane to turn left. These tendencies must be factored into the design of the airplane or corrected by the pilot.

Torque

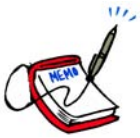

Show the slide of Figure A-1 to the cadets.

Newton's Third Law of Motion states that every action has an equal and opposite reaction. This means that the clockwise rotation of the propeller is counteracted by a counter-clockwise rotation of the airplane. This reaction tends to force the left wing downwards, producing a tendency to turn left.

To correct this, airplanes can be designed with a right turning tendency, typically by having a slightly greater angle of incidence on the left wing. During takeoff (when the engine is usually running at full power) additional corrections must be applied by the pilot (rudder and / or ailerons) because of the increased amount of torque.

Asymmetric Thrust



Show the slide of Figure A-2 to the cadets.

At high angles of attack and high power settings (eg, takeoff) the blade of the propeller that is travelling down (the blade on the right) has a greater angle of attack than the blade that is travelling up. This creates more thrust from the right side of the propeller and creates a tendency for the aircraft to yaw or turn left.

To correct for asymmetric thrust (also known as P Factor), the pilot uses right rudder.

Precession



Show the slide of Figure A-3 to the cadets.

The spinning propeller acts like a gyroscope and tends to stay in the same plane of rotation, and resists any change to the plane. When a perpendicular force is applied to change the plane, a resultant force called precession is the result.

The force of precession is ahead of the plane of rotation and 90 degrees to the original applied force. Precession occurs in airplanes when the tail is lifted or lowered (eg, takeoff in a tailwheel aircraft).

To correct for precession, the pilot uses right rudder.

Slipstream



Show the slide of Figure A-4 to the cadets.

The air being pushed backwards by the propeller has a corkscrew motion and is called the slipstream. This causes more pressure on the left side of the fuselage and tail, and results in a tendency for the airplane to turn left.

The effects of the slipstream can be corrected by having the engine thrust line offset to the right, and / or by offsetting the vertical fin. When the airspeed of the airplane is low (eg, takeoff) the pilot may have to apply right rudder.

CONFIRMATION OF TEACHING POINT 1

QUESTIONS:

- Q1. What four factors contribute to an airplane's left turning tendency?
- Q2. Which propeller blade has a greater angle of attack at high angles of attack?
- Q3. Which factor produces more pressure on the left side of the fuselage and tail?

ANTICIPATED ANSWERS:

- A1. Torque, asymmetric thrust, precession, and slipstream.
- A2. The blade moving downwards.
- A3. Slipstream.

Teaching Point 2**Explain climbs and glides.**

Time: 10 min

Method: Interactive Lecture

CLIMBS

During level flight at a constant airspeed, the engine produces thrust equal to drag, and the wings produce lift equal to weight. A pilot can initiate a climb by increasing the angle of attack (eg, pulling back on the stick) to produce more lift. The aircraft will climb but the airspeed will decrease.



Show the slide of Figure A-5 to the cadets.

The pilot could also initiate a climb by increasing the power setting of the engine (which would cause an increase in airspeed). If the angle of attack is not changed, the increased airspeed will create additional lift and the airplane will climb.

Once the climb is established, the aircraft is again in equilibrium. The attitude of the aircraft creates a rearward component of weight. In this state, thrust must equal drag plus the rearward component of weight and lift must equal weight, less its rearward component.

The extra power available from the engine to overcome the rearward component of weight determines the aircraft's ability to climb. As the altitude of the airplane increases, the air becomes less dense, and the available power of the engine decreases. The climb angle is reduced and further climbing eventually becomes impossible. The altitude at which this occurs is the absolute ceiling of the airplane.

Best rate of climb (V_Y). The rate of climb that gains the most altitude in the least amount of time. It is normally used during takeoff after all obstacles have been cleared.

Best angle of climb (V_X). The angle of climb that gains the most altitude in a given distance. It is used during takeoff to clear obstacles at the departure end of the runway.

Normal climb (cruise climb). The rate of climb recommended for prolonged climbs. It provides better cooling, visibility, and control compared to V_Y .

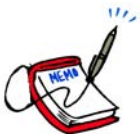
GLIDES

Show the slide of Figure A-6 to the cadets.

During a glide, the engine is producing minimal power and the airplane is influenced by gravity. In this state, equilibrium is achieved by balancing lift, weight, and drag.

To increase airspeed, the angle of the glide must be increased. Reducing airspeed creates a shallower glide, until the point of a stall.

A windmilling propeller (the propeller is being spun by the relative wind, not the power of the engine) can reduce the gliding distance by approximately 20 percent. Although getting the propeller to stop can increase the gliding

range, it is difficult to perform. Additionally, the chances of restarting the engine are improved if the propeller is windmilling.

Best glide speed for range (maximum lift / drag). The airspeed which allows the aircraft to glide the farthest distance for altitude lost.

Best glide speed for endurance (minimum sink). The airspeed which allows the aircraft to remain in the air for the longest period of time.

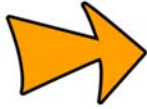

Most airplane pilots are only concerned with the best glide speed for range airspeed as it is the airspeed usually used after an engine failure.

Sailplane (glider) pilots are concerned with both airspeeds. They use the minimum sink speed to remain in an area of rising air for as long as possible to extend the time of the flight.

CONFIRMATION OF TEACHING POINT 2

QUESTIONS:

- Q1. What is V_Y ?
- Q2. What is V_X ?
- Q3. What three forces must be balanced during a glide to achieve equilibrium?

ANTICIPATED ANSWERS:

- A1. Best rate of climb.
- A2. Best angle of climb.
- A3. Lift, weight, and drag.

Teaching Point 3

Explain turns.

Time: 5 min

Method: Interactive Lecture

TURNS



Show the slide of Figure A-7 to the cadets.

In straight and level flight, the lift created by the wings is acting perpendicular to the wing span (vertically). To turn the aircraft, the pilot uses the ailerons to bank the aircraft in the direction of the desired turn. The lift is acting perpendicular to the wing span, but has both a horizontal and vertical component. It is the horizontal component of the lift (known as the centripetal force) that makes the aircraft turn. The opposing force (known as the centrifugal force) pulls the aircraft to the outside of the turn.

To maintain a constant altitude, the vertical component of lift must remain equal to the weight of the aircraft. This can be accomplished by increasing the angle of attack or the airspeed (by adding power). If the angle of

attack is increased, additional power must be added to maintain the desired airspeed. The steeper the angle of bank, the more the angle of attack and power must be increased to maintain altitude.

At any given airspeed, a steeper angle of bank produces:

- a higher rate of turn,
- a lower radius of turn,
- a higher stalling speed, and
- a higher load factor (G load).

At any given angle of bank, a higher airspeed produces:

- a lower rate of turn, and
- a larger radius of turn.

Load Factors in Turns



Show the slide of Figure A-8 to the cadets.

Turns increase the load factor. The steeper the angle of bank, the higher the load factor is. For example, a 60-degree bank produces a load factor of two. This means an aircraft that weighs 2 500 kg will have an equivalent weight of 5 000 kg. Very steep turns can produce very high load factors and may lead to structural failure.

CONFIRMATION OF TEACHING POINT 3

QUESTIONS:

- Q1. Which component of lift makes the aircraft turn when it is banked?
- Q2. What is the name of the force that pulls the aircraft towards the outside of the turn?
- Q3. At any given airspeed, what does a steeper angle of bank produce?

ANTICIPATED ANSWERS:

- A1. The horizontal component (centripetal force).
- A2. The centrifugal force.
- A3. A steeper angle of bank produces:
- higher rate of turn,
 - lower radius of turn,
 - higher stalling speed, and
 - higher load factor (G load).

Teaching Point 4**Explain stalls, spins, and spirals.**

Time: 15 min

Method: Interactive Lecture

STALLS

Show the slide of Figure A-9 to the cadets.

At low angles of attack, the air flows smoothly over the wing. As the angle of attack increases, the separation point between the laminar area and the turbulent area moves forward. At the critical angle of attack (determined by the design of the airfoil) the laminar flow separates from the wing and a large loss of lift (called a stall) occurs.



An airplane will stall:

- if the critical angle of attack is exceeded,
- at any airspeed if the critical angle of attack is exceeded, and
- at any attitude if the critical angle of attack is exceeded.

Symptoms of a Stall

As a stall is approached, there is usually a light buffeting of the airframe and controls. Lateral control of the aircraft is reduced as the ailerons lose their effectiveness in the separated airflow. When the stall is reached, lift is lost and the nose of the airplane drops.

A stall occurs gradually on most airplanes, giving the pilot time to recognize and react to the symptoms. If there is wash-out designed in the wing, the wing root will stall first and the ailerons will still be effective in the early stages of the stall.

Factors Affecting Stalls

Weight. Increasing the weight of an airplane increases the indicated airspeed at which it will stall.

Centre of gravity. Moving the centre of gravity forward increases the indicated airspeed at which the airplane will stall. Moving the centre of gravity rearward decreases the indicated airspeed at which it will stall. Moving the centre of gravity beyond the design limits will affect handling, stability, stall characteristics, and stall recovery.

Turbulence. An upward gust increases the angle of attack of the wing and could cause the airplane to exceed the critical angle at a lower airspeed than would be expected in calm air.



Show the slide of Figure A-10 to the cadets.

Turns. As the angle of bank in a turn is increased, the load factor and stalling speed increase. The stall speed in a turn can be calculated by multiplying the normal stall speed by the square root of the load factor.

Flaps. Increase the lift produced by the wing and lower the indicated airspeed at which the airplane will stall.

Snow, frost and ice. Accumulations on the wing (including dirt and bugs) disrupt the airflow and add additional weight (especially accumulations of ice) causing an increase in the airspeed at which the airplane will stall and a lower critical angle of attack.

Heavy rain. Increases the airspeed at which an airplane will stall as the water forms a film over the surface of the wing. Raindrops create craters and waves in the film, reducing lift and increasing drag, much like frost does.

Stall Recovery

To recover from the stall, the wing has to produce sufficient lift. In general, the stall recovery for most light aircraft involves reducing the angle of attack (below the critical angle of attack). Applying power to increase the airspeed may also be part of the recovery process.

The pilot operating handbook (POH) for most light aircraft lists the following steps to recover from a stall:

1. Reduce the angle of attack by moving the control column forward.
2. Apply power to increase the airspeed.
3. Return to level flight.

SPINS



Show the slide of Figure A-11 to the cadets.

A spin may develop after a stall if one wing becomes disturbed and produces a different amount of lift. This may happen as a result of using ailerons, applying rudder to produce yaw, entering a stall in a banked attitude, or movement of a wing by turbulent air.

When one wing drops, it has a larger angle of attack and produces less lift (as it has already stalled) compared to the wing that is moving up which has a smaller angle of attack. This difference accelerates the rolling motion and autorotation sets in.



Show the slide of Figure A-12 to the cadets.

Stages of a Spin

A spin has three stages:

1. incipient,
2. developed, and
3. recovery.

The incipient stage occurs from the time the airplane stalls and rotation starts until the spin axis becomes vertical or nearly vertical.

In the developed stage, the angles and motions of the airplane are stabilized and the flight path is nearly vertical. During this stage the airspeed has stabilized.



A spin is a stalled condition with a constant airspeed during the developed stage.

Spin characteristics are different for different aircraft so the technique for recovery from the specific POH must be followed. In the absence of recommendations from the manufacturer, most light airplanes can be brought out of a spin by following these steps:

1. Decrease power to idle and neutralize ailerons.
2. Apply full rudder in the opposite direction of the rotation.
3. Move the control column forward to reduce the angle of attack and unstall the wings.
4. When rotation stops, neutralize the rudder, level the wings, and ease out of the dive.

SPIRALS

A spiral is a steep descending turn in which the aircraft rapidly loses altitude while the airspeed rapidly increases.

The characteristics of a spiral include:

- excessive angle of bank,
- rapidly increasing airspeed, and
- rapidly increasing rate of descent.

The recovery process for a spiral is as follows:

1. Decrease power to idle and level the wings simultaneously with coordinated use of rudder and ailerons.
2. Ease out of the dive.
3. Apply power as required to maintain altitude.



A spiral is not a stalled condition. An improper recovery can cause an excessive load factor and lead to structural failure.

CONFIRMATION OF TEACHING POINT 4

QUESTIONS:

- Q1. What must be exceeded in order for a stall to occur?
- Q2. What does the stall speed do as the angle of bank in a turn is increased?
- Q3. What is the difference between a spin and a spiral?

ANTICIPATED ANSWERS:

- A1. The critical angle of attack.
- A2. The stall speed increases.
- A3. A spin is a stalled condition and has a constant airspeed. A spiral is not a stalled condition and has a rapidly increasing airspeed.

Teaching Point 5

Explain airspeed limitations.

Time: 5 min

Method: Interactive Lecture

To reduce the risk of structural failure from an excessive load factor, airplane manufacturers publish a number of airspeed limitations in the POH.

Never exceed (maximum permissible dive) speed (V_{NE}). The maximum airspeed at which the airplane may be operated in smooth air.

Maximum structural cruise (normal operating limit) speed (V_{NO}). The maximum cruise airspeed at which the airplane was designed to operate.

Manoeuvring speed (V_A). The maximum airspeed at which the flight controls can be fully deflected without causing structural damage.

Maximum gust intensity speed (V_B). The maximum airspeed for penetration of gusts of maximum intensity. For most light airplanes V_A and V_B are the same.

Maximum flaps extended speed (V_{FE}). The maximum airspeed at which the airplane may be operated with the flaps extended.

CONFIRMATION OF TEACHING POINT 5

QUESTIONS:

- Q1. What does V_{NE} specify?
- Q2. What is the maximum airspeed at which the flight controls can be fully deflected?
- Q3. What does V_{FE} specify?

ANTICIPATED ANSWERS:

- A1. The maximum airspeed at which the airplane may be operated in smooth air.
- A2. V_A .
- A3. The maximum airspeed at which the airplane may be operated with the flaps extended.

END OF LESSON CONFIRMATION**QUESTIONS:**

- Q1. What happens to the load factor in a turn?
- Q2. What are the characteristics of a spiral?
- Q3. What is the maximum cruise airspeed at which the airplane was designed to operate?

ANTICIPATED ANSWERS:

- A1. The load factor increases.
- A2. The characteristics of a spiral include:
- excessive angle of bank,
 - rapidly increasing airspeed, and
 - rapidly increasing rate of descent.
- A3. V_{NO} .

CONCLUSION

HOMEWORK / READING / PRACTICE

Nil.

METHOD OF EVALUATION

Nil.

CLOSING STATEMENT

Future aviation training and instructional duties depend on knowledge of left turning tendencies, climbs, glides, turns, stalls, spins, spirals and airspeed limitations.

INSTRUCTOR NOTES / REMARKS

Cadets who are qualified Advanced Aviation may assist with this instruction.

REFERENCES

C3-116 ISBN 0-9680390-5-7 MacDonald, A. F., & Peppler, I. L. (2000). *From the ground up: Millennium edition*. Ottawa, ON: Aviation Publishers Co. Limited.

THIS PAGE INTENTIONALLY LEFT BLANK

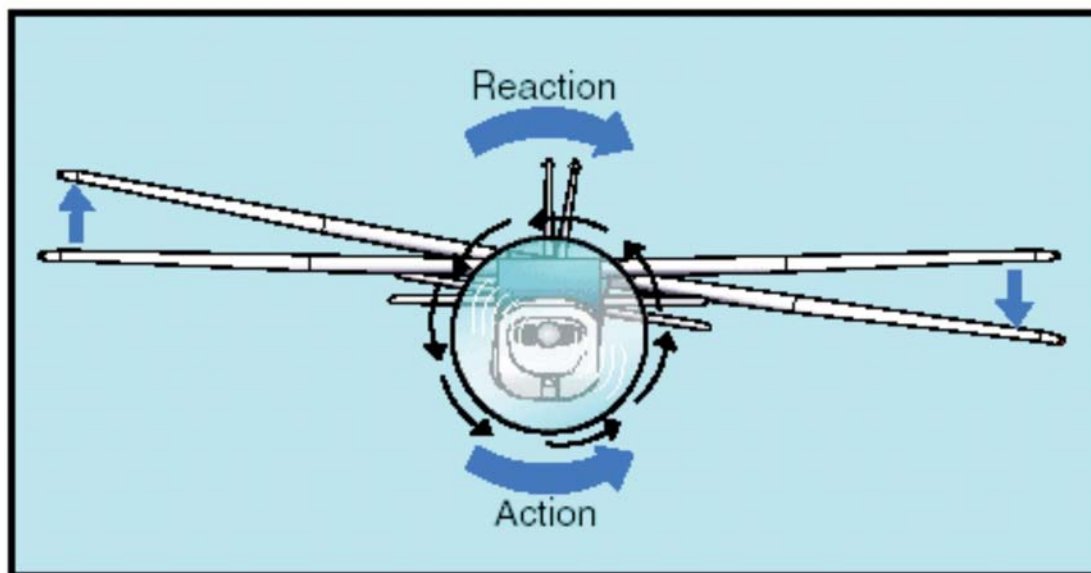

Figure A-1 Torque Reaction

Note. From "Propeller Aerodynamics", *Free Online Private Pilot Ground School*. Retrieved November 6, 2008, from <http://www.free-online-private-pilot-ground-school.com/propeller-aerodynamics.html>

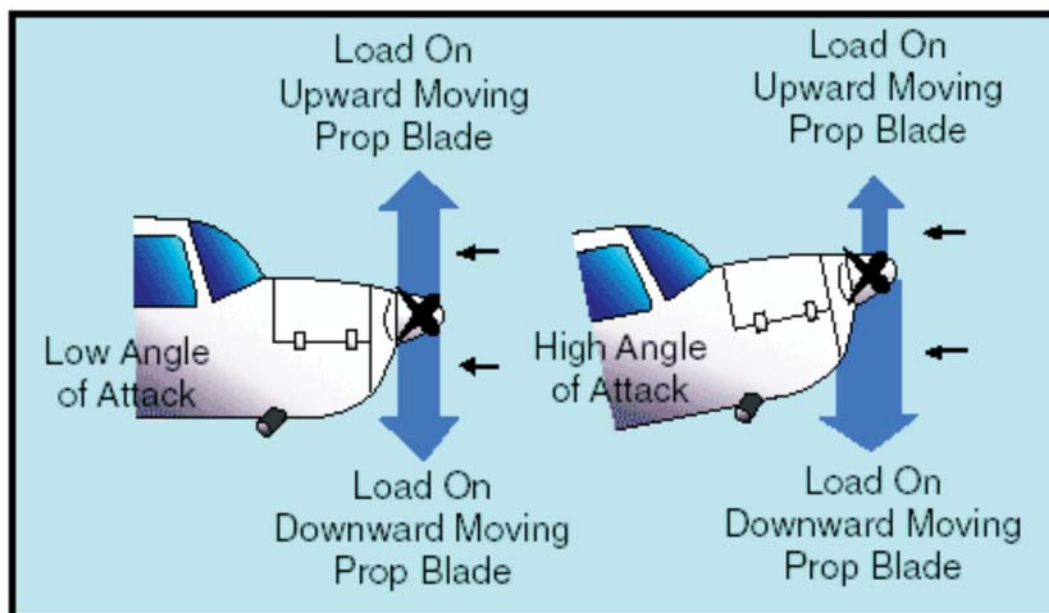

Figure A-2 Asymmetric Thrust (P Factor)

Note. From "Propeller Aerodynamics", *Free Online Private Pilot Ground School*. Retrieved November 6, 2008, from <http://www.free-online-private-pilot-ground-school.com/propeller-aerodynamics.html>

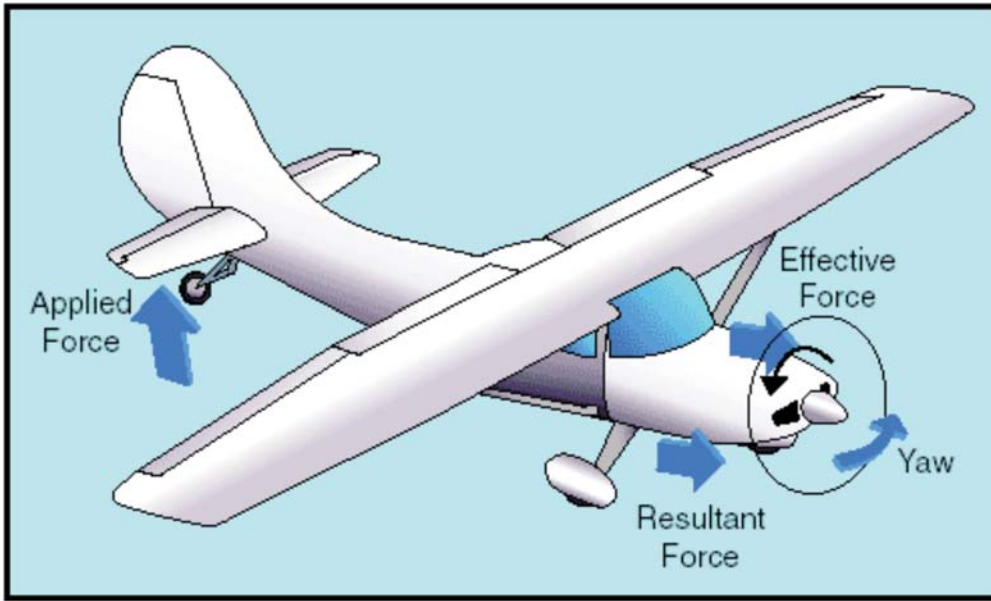

Figure A-3 Precession When the Tail is Lifted

Note. From "Propeller Aerodynamics", *Free Online Private Pilot Ground School*. Retrieved November 6, 2008, from <http://www.free-online-private-pilot-ground-school.com/propeller-aerodynamics.html>

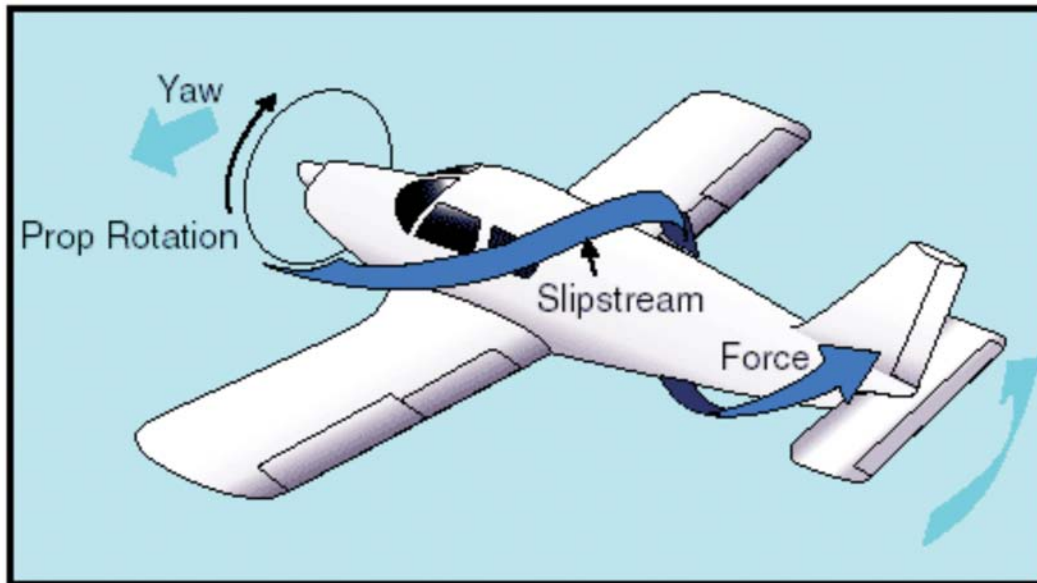

Figure A-4 Slipstream

Note. From "Propeller Aerodynamics", *Free Online Private Pilot Ground School*. Retrieved November 6, 2008, from <http://www.free-online-private-pilot-ground-school.com/propeller-aerodynamics.html>

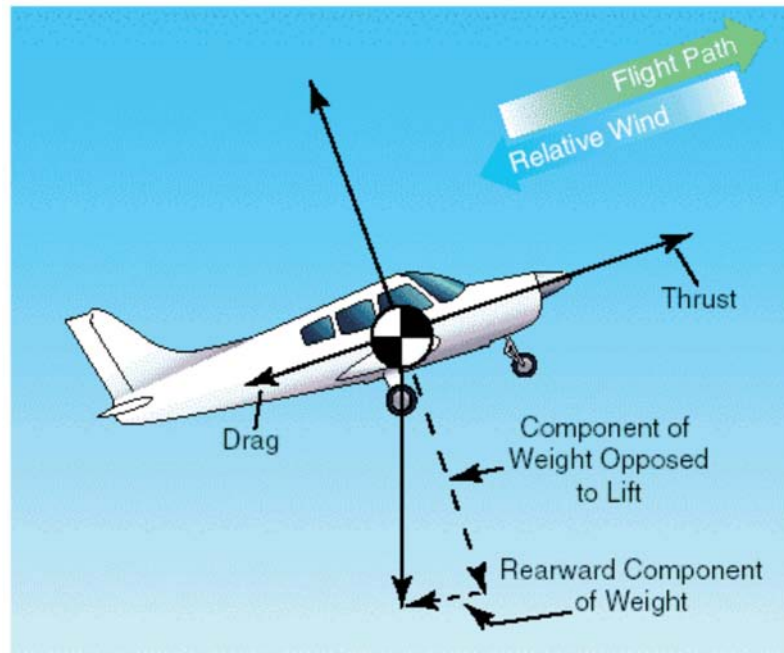

Figure A-5 Forces in a Climb

Note. From "Aerodynamics in Flight", *Free Online Private Pilot Ground School*. Retrieved November 6, 2008, from http://www.free-online-private-pilot-ground-school.com/Aerodynamics_in_flight.html

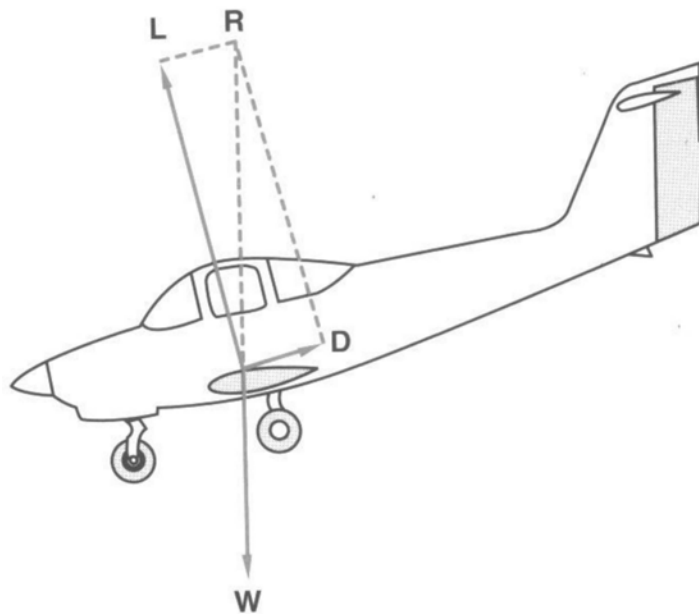

Figure A-6 Forces in a Glide

Note. From *From the Ground Up: Millennium Edition* (p. 34), by A. F. MacDonald and I. L. Peppler, 2000, Ottawa, ON: Aviation Publishers Co. Limited. Copyright 2000 by Aviation Publishers Co. Limited.

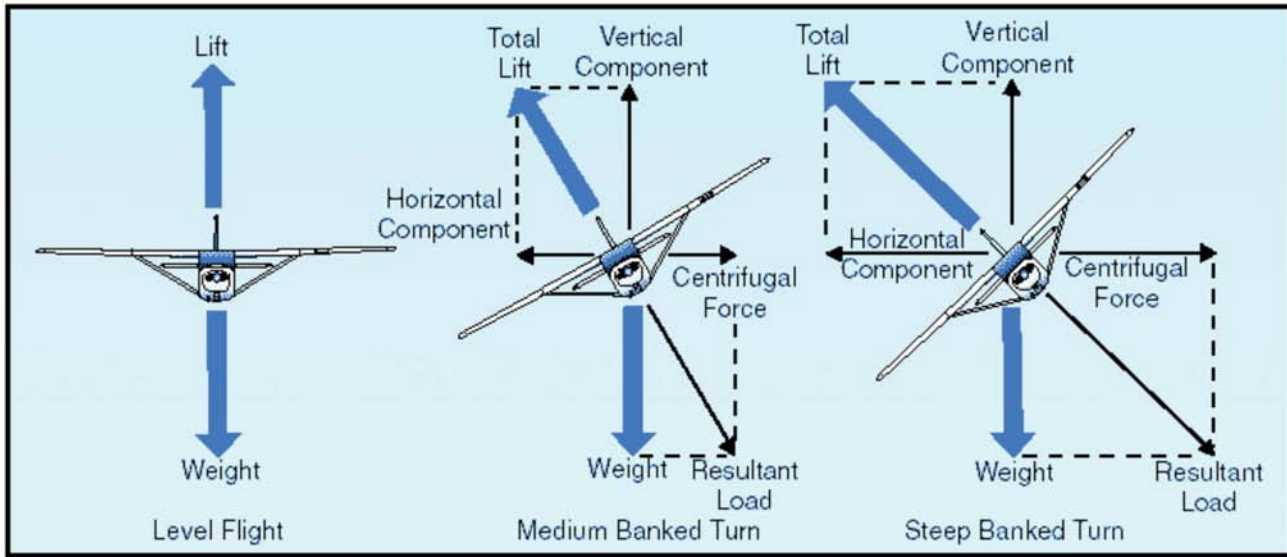

Figure A-7 Forces in a Turn

Note. From "Aerodynamics in Flight", *Free Online Private Pilot Ground School*. Retrieved November 6, 2008, from http://www.free-online-private-pilot-ground-school.com/Aerodynamics_in_flight.html

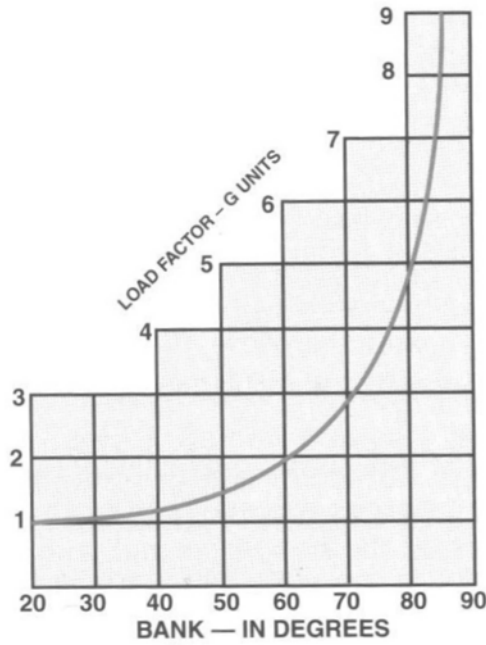

Figure A-8 Load Factors in Turns

Note. From *From the Ground Up: Millennium Edition* (p. 35), by A. F. MacDonald and I. L. Pepler, 2000, Ottawa, ON: Aviation Publishers Co. Limited. Copyright 2000 by Aviation Publishers Co. Limited.

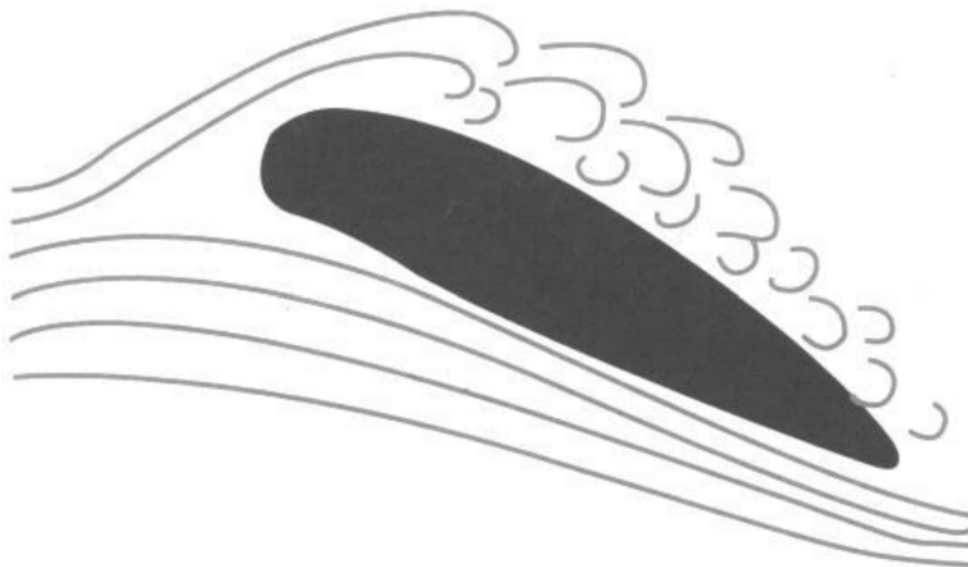

Figure A-9 Stall

Note. From *From the Ground Up: Millennium Edition* (p. 35), by A. F. MacDonald and I. L. Peppler, 2000, Ottawa, ON: Aviation Publishers Co. Limited. Copyright 2000 by Aviation Publishers Co. Limited.



STALL SPEED, POWER OFF			
GROSS WEIGHT <i>2800 LBS.</i>	ANGLE OF BANK		
	 0°	 30°	 60°
CONFIGURATION			
FLAPS UP	64	69	91
FLAPS 20°	57	61	81
FLAPS 40°	55	59	78

Figure A-10 Stall Speed in Turns

Note. From *From the Ground Up: Millennium Edition* (p. 35), by A. F. MacDonald and I. L. Peppler, 2000, Ottawa, ON: Aviation Publishers Co. Limited. Copyright 2000 by Aviation Publishers Co. Limited.

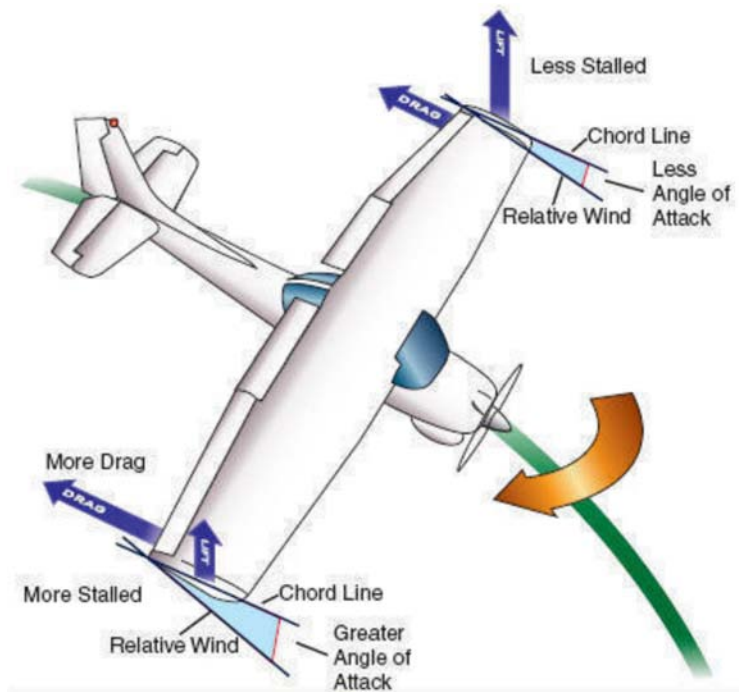

Figure A-11 Spin

Note. From "What is a Spin?", *Over the Airwaves*. Retrieved November 12, 2008, from <http://overtheairwaves.com/Vol3-111.jpg>

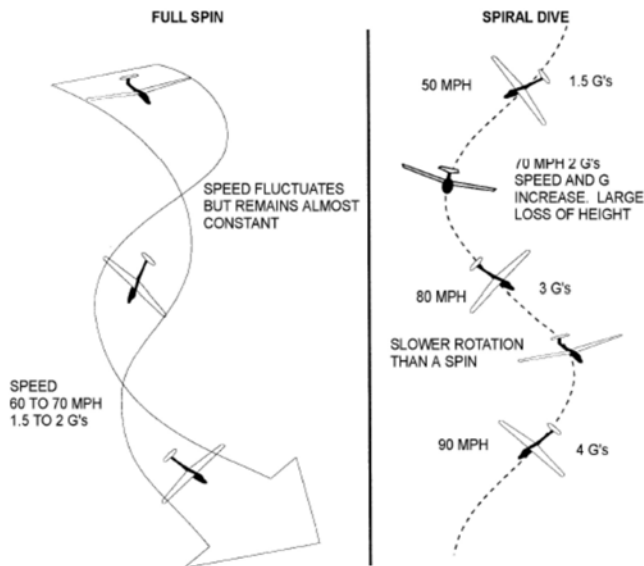

Figure A-12 Spin and Spiral Recognition

Note. From *Air Cadet Gliding Program Manual* (p. 6-6-4), by Air Force Training, 2009, Ottawa, ON: Department of National Defence.



ROYAL CANADIAN AIR CADETS
PROFICIENCY LEVEL FOUR
INSTRUCTIONAL GUIDE



SECTION 4

EO C431.02 – DEMONSTRATE TURNS, CLIMBS AND DESCENTS IN A FLIGHT SIMULATOR

Total Time: 90 min

PREPARATION

PRE-LESSON INSTRUCTIONS

Resources needed for the delivery of this lesson are listed in the lesson specification located in A-CR-CCP-804/PG-001, *Proficiency Level Four Qualification Standard and Plan*, Chapter 4. Specific uses for said resources are identified throughout the instructional guide within the TP for which they are required.

Review the lesson content and become familiar with the material prior to delivering the lesson.

Photocopy the handouts located at Attachments A and B for each cadet.

Create a scenario (eg, location, weather, aircraft) for the aircraft flight simulator IAW the manual provided with the software.

Set up the simulator with the scenario created.

PRE-LESSON ASSIGNMENT

Nil.

APPROACH

An interactive lecture was chosen for TPs 1 and 2 to give direction on procedures and present basic or background information about flight simulation.

A demonstration and performance was chosen for TP 3 as it allows the instructor to explain and demonstrate turns, climbs and descents in a flight simulator while providing an opportunity for the cadets to practice the skills under supervision.

INTRODUCTION

REVIEW

Nil.

OBJECTIVES

By the end of this lesson the cadet shall have demonstrated turns, climbs and descents in a flight simulator.

IMPORTANCE

It is important for cadets to demonstrate turns, climbs and descents in a flight simulator to develop a better understanding of the principles of flight and stimulate an interest in aviation. This will also serve as a solid foundation for any cadet who participates in a demonstration flight or flying training in the future.

Teaching Point 1**Explain any safety considerations related to the location or design of the flight simulator.**

Time: 5 min

Method: Interactive Lecture



Arrange the cadets so they can hear the safety briefing prior to using the flight simulator.



This briefing is being conducted to pass on safety considerations for use of the flight simulator. The actual content of the briefing will vary by region and squadron based on the squadron assets, the location of the assets, and other environmental factors. However, the following should be covered:

- DND regulations concerning the appropriate use of computers, including:
 - CATO 11-07, *Internet Acceptable Use—Cadet Program*,
 - DAOD 6001, *Internet*, and
 - Regional Orders;
- location of the nearest fire exit in case of fire,
- awareness of any moving parts of the simulator, and
- proper entry and exit techniques to avoid damage to assets.

CONFIRMATION OF TEACHING POINT 1

Confirmation questions for this TP will depend on the content covered.

Teaching Point 2**Explain how to manipulate the necessary control inputs and the location of necessary instruments.**

Time: 10 min

Method: Interactive Lecture

NECESSARY CONTROL INPUTS**Control Column or Yoke**

Using a control yoke in a flight simulator is preferable. Accordingly, the following will need to be adjusted if a control column is used instead.

The control yoke is located directly in front of the pilot in the centre of the pilot's side of the instrument panel. The control yoke is very much like the steering wheel of a car, both in look and function. The yoke is designed to move on two planes of motion.

The first plane of motion is left and right. The control yoke will usually move to approximately 45 degrees left or right of centre when moved like a steering wheel. This motion is what controls the ailerons of the simulated airplane. To roll left, turn the yoke left. To roll right, turn the yoke right. Remember, this must be used as well as the rudder in order to properly turn the aircraft.

The control yoke also moves back and forth. The steering column of the yoke moves in and out of the main assembly. This controls the elevator of the simulated aircraft. To pitch up, pull back (towards the pilot). To pitch down, push forward (away from the pilot).



Pitch will change the altitude, but more importantly the airspeed.

Rudder Pedals

On the floor of the simulator there are two pedals. If the left pedal is pushed forward, the right one moves back and vice versa. These pedals control the rudder of the simulated aircraft. To yaw left, push on the left pedal. To yaw right, push on the right pedal.



Rudder pedals move in different directions so pressure must be taken off the opposite pedal in order for the movement to take place.

LOCATION OF NECESSARY INSTRUMENTS



Distribute the handout located at Attachment A to each cadet.

The instruments of the simulated aircraft will be displayed in front of the pilot, laid out above the control yoke on what is called an instrument panel. The four instruments that are of significance are the airspeed indicator (ASI), vertical speed indicator (VSI), altimeter, and turn coordinator.

ASI. Shows an aircraft's speed through the air.

VSI. Shows the rate at which an aircraft is ascending or descending.

Altimeter. Shows the altitude of an aircraft.

Turn Coordinator. Shows rate of roll as well as the rate of turn of the aircraft.



Function of the ASI, VSI, altimeter and turn coordinator was discussed in M431.02 (Describe Flight Instruments).

CONFIRMATION OF TEACHING POINT 2**QUESTIONS:**

- Q1. Where is the control yoke located?
- Q2. Where are the instruments located?
- Q3. How is pitch controlled?

ANTICIPATED ANSWERS:

- A1. Directly in front of the pilot in the centre of the pilot's side of the instrument panel.
- A2. In front of the pilot, laid out above the control yoke on what is called an instrument panel.
- A3. By moving the yoke towards or away from the pilot.

Teaching Point 3

Explain, demonstrate and have the cadets practice turns, climbs and descents using a flight simulator.

Time: 70 min

Method: Demonstration and Performance

ACTIVITY**OBJECTIVE**

The objective of this activity is to allow the cadets to practice turns, climbs and descents and witness their effect on the pitot static instruments and the turn coordinator.

RESOURCES

- flight simulator (Microsoft flight simulator, computer, control yoke, and rudder pedals; or Link),
- scenario using a local airport, no weather, and positioned 1 000 feet above ground level (AGL), and
- Climbs, Turns and Descents Handout located at Attachment B.

ACTIVITY LAYOUT

Training should be conducted for a light training single engine aircraft such as:

- a Cessna 172, or
- a Piper J-3C-65 Cub.

This will depend on the location of the flight simulator.

ACTIVITY INSTRUCTIONS

1. Start the simulator with the scenario created prior to the lesson.
2. Using the flight simulator, explain and demonstrate turns, climbs and descents by climbing to 5 000 feet AGL, making turns and descending to 1 000 feet AGL.



Specific details on how to conduct turns, climbs and descents can be found in:

- the Transport Canada *Flight Training Manual*,
- the *Computerized Aircraft Simulation Center*,
- the Pilots Operating Handbook (POH), and / or
- the operating instructions for the flight simulator program.

3. Distribute the handout located at Attachment B to each cadet. The handout reflects the sequence in which the instructor will explain and demonstrate turns, climbs and descents.
4. Have the cadets take turns in the flight simulator, practicing turns, climbs and descents as demonstrated.
5. Give each cadet verbal and physical assistance as necessary as they practice turns, climbs and descents.
6. Provide each cadet an equal amount of time. This means that the 70 minutes should be divided as evenly as possible based on the number of cadets in the class and the number of flight simulators available.
7. Debrief each cadet as they finish their individual flight. The debrief should include the following:
 - a. the overall performance of the cadet,
 - b. the sequences where the cadet performed strongly,
 - c. the sequences where the cadet performed weakly, and
 - d. how to improve their performance.

SAFETY

Nil.

CONFIRMATION OF TEACHING POINT 3

The cadets' participation in the activity will serve as the confirmation of this TP.

END OF LESSON CONFIRMATION

The cadets' participation in practicing turns, climbs and descents in the flight simulator will serve as the confirmation of this lesson.

CONCLUSION

HOMEWORK / READING / PRACTICE

Nil.

METHOD OF EVALUATION

Nil.

CLOSING STATEMENT

It has been stated by many flight instructors that a significant difference can be seen in the quality of students who used a flight simulator compared to those who did not. The military is a large user of computer-based flight simulators, as are Air Canada and WestJet. Continued training on flight simulators will enhance preparation for future flight training.

INSTRUCTOR NOTES / REMARKS

All staff should be familiarized with the operation of the flight simulator prior to the cadets arriving. This will allow them to troubleshoot, and give them a better perspective for instructing.

Additional instructors are required for this lesson. There should be one instructor per two flight simulators.

Cadets who are qualified Advanced Aviation may assist with this instruction.

REFERENCES

C3-139 ISBN 0-7715511-5-0 Transport Canada. (1999). *Flight training manual 4th edition revised*. Ottawa, ON: Transport Canada.

C3-156 *Computerized Aircraft Simulation Center*. (2007). Retrieved October 2, 2007, from http://www.regions.cadets.forces.gc.ca/pac/aircad/flight/casc_lessons_e.asp

THIS PAGE INTENTIONALLY LEFT BLANK



Figure A-1 Cessna Flight Instrument Panel

Note. From "Design a Virtual Cockpit Instrument Panel", Ngee Ann Polytechnic, 2007. Retrieved October 31, 2007, from <http://www.learnerstogether.net/avionics-project-design-problem-based-learning/56>

THIS PAGE INTENTIONALLY LEFT BLANK

CLIMBS, TURNS AND DESCENTS HANDOUT

The handout is presented to reflect the sequence in which the instructor will explain and demonstrate climbs, turns and descents.

CLIMBS

Climbs are executed by doing the following:

1. Adjust the pitch angle to obtain climb airspeed.
2. Increase the power to maintain airspeed.
3. Climb to the desired altitude.
4. Upon reaching the desired altitude, resume a level attitude and adjust power to maintain altitude and airspeed.
5. For any climb, follow the sequence: attitude, power, trim (APT).

TURNS

Turns are executed by doing the following:

1. Look out from the outside to the inside of the turn. A good look out is the most important part of airmanship as is essential for safe flying.
2. Roll the airplane in the desired direction, using the rudder to stay coordinated. Stay coordinated by "stepping on the ball" of the turn coordinator. That is, if the ball of the turn coordinator is to the right, apply more right rudder and vice versa.
3. Once the desired angle of bank has been reached, reduce the yoke input as required to maintain that angle of bank.

Gentle turn. A turn with up to 15 degrees angle of bank.

Medium turn. A turn with approximately 30 degrees angle of bank.

Steep turn. A turn with at least 45 degrees angle of bank. When executing a steep turn, as the angle of bank passes 30 degrees, back-stick pressure must be applied to maintain attitude and altitude. The power setting must be increased to maintain altitude.

DESCENTS

Descents are executed by doing the following:

1. Decrease power, adjust the attitude to reach and maintain the descent speed, and adjust the trim.
2. For any descent, follow the sequence: power, attitude, trim (PAT).
3. Upon reaching the desired altitude, resume a level attitude and adjust power to maintain altitude and airspeed.

THIS PAGE INTENTIONALLY LEFT BLANK



ROYAL CANADIAN AIR CADETS
PROFICIENCY LEVEL FOUR
INSTRUCTIONAL GUIDE



SECTION 5

EO C431.03 – FLY A RADIO-CONTROLLED AIRCRAFT

Total Time:	90 min
-------------	--------

PREPARATION

PRE-LESSON INSTRUCTIONS

Resources needed for the delivery of this lesson are listed in the lesson specification located in A-CR-CCP-804/PG-001, *Proficiency Level Four Qualification Standard and Plan*, Chapter 4. Specific uses for said resources are identified throughout the instructional guide within the TP for which they are required.

Review the lesson content and become familiar with the material prior to delivering the lesson.

Construct and / or assemble a radio-controlled aircraft for use by cadets.

Charge multiple batteries for use with radio-controlled aircraft.

Assistant instructors are required for this lesson.

PRE-LESSON ASSIGNMENT

Nil.

APPROACH

A practical activity was chosen for this lesson as it is an interactive way to introduce the cadets to flying a radio-controlled aircraft in a safe and controlled environment. This activity contributes to the development of skills and knowledge in a fun and challenging setting.

INTRODUCTION

REVIEW

Nil.

OBJECTIVES

By the end of this lesson the cadet shall have flown a radio-controlled aircraft.

IMPORTANCE

It is important for cadets to fly a radio-controlled aircraft as it provides an opportunity to apply the principles of flight in a fun and practical way.

Teaching Point 1

IAW the instructions supplied with the radio-controlled aircraft and the Model Aeronautics Association of Canada (MAAC) safety code, have the cadet fly a radio-controlled aircraft.

Time: 80 min

Method: Practical Activity

BACKGROUND KNOWLEDGE

Radio-Controlled Aircraft

Radio-controlled aircraft are more complicated and expensive than free-flight gliders or rubber-powered airplanes. They are an exciting way to apply the principles of flight in a practical way. They can be scratch-built from plans, built from kits, assembled from almost-ready-to-fly (ARF) kits, or assembled from ready-to-fly (RTF) packages.

Small, light-weight, electric-powered helicopters are also a viable alternative to a conventional radio-controlled airplane. They are available in different sizes in RTF packages and can be flown indoors in smaller spaces than required by an airplane. Most micro-helicopters on the market use counter-rotating main rotors that make a stable, easy-to-hover helicopter.



The Blade CX Series (CX, CX2, CX3 and MCX), from E-Flite are among the most popular entry-level helicopters. They come in an RTF package and include a radio transmitter-receiver combination that allows multiple aircraft to operate at the same time without interference.

Figures 1 and 2 show the Blade CX2 and Blade MCX, respectively.

When learning to operate a radio-controlled helicopter, it is recommended that a training gear set is attached to the landing skids to reduce rollovers as shown in Figure 3.

Ensure that there is an ample supply of spare parts (blades, shafts, and heads) available to repair any damages caused by a crash.

Having multiple batteries available (a minimum of three per helicopter) minimizes the time spent waiting while batteries are recharging.



Figure 1 Blade CX2

Note. From "Horizon Hobby", *E-Flite Blade CX2*. Retrieved November 5, 2008, from <http://www.horizonhobby.com/Products/Gallery.aspx?ProdID=EFLH1250&Index=0>



Figure 2 Blade MCX

Note. From "Horizon Hobby", *E-Flite Blade MCX*. Retrieved November 5, 2008, from <http://www.horizonhobby.com/Products/Gallery.aspx?ProdID=EFLH2200&Index=4>



Figure 3 Blade CX2 With Training Gear Installed

Note. From "Elite Models", *Blade CX2*. Retrieved November 5, 2008, from <http://www.elitemodelsonline.co.uk/Products/Helicopters/Helicopters+Spares/E-Flite/Blade+CX2>



A radio-controlled airplane can be built easily and quickly from common materials such as corrugated plastic (commonly used for signs) and polyvinyl chloride (PVC) downspout. These simple plastic airplane designs (SPADs) are inexpensive and durable.

Information and free plans for SPADs can be found at <http://www.spadtothebone.com>

The Debonair is designed to be used as a trainer and is shown at Figure 4.



Figure 4 SPAD Debonair

Note. Created by Director Cadets 3, 2008, Ottawa, ON: Department of National Defence.

RTF packages (containing an airframe, engine or motor, radio gear, and hardware) can be assembled in a few hours and generally contain almost everything needed to go flying except for field items such as:

- glue,
- starting equipment, and
- fuel / batteries.



Figure 5 and 6 shows examples of an RTF aircraft suitable for first-time fliers. The Vapor Bind-N-Fly model also comes as the Vapor RTF model which includes the radio transmitter and is for indoor flying only.



Figure 5 Alpha 40 DSM2 RTF

Note. From "Hangar 9", *Alpha 40 DSM2 RTF*. Retrieved November 5, 2008, from <http://www.hangar-9.com/Products/Default.aspx?ProdID=HAN4400>



Figure 6 Vapor Bind-N-Fly

Note. Created by Director Cadets 3, 2008, Ottawa, ON: Department of National Defence.

Computer simulators for radio-controlled aircraft are available and can be used to provide training in a safe and controlled environment without having to worry about the cost and time associated with repairing an aircraft after a crash.

Most of the simulators available come with a "transmitter" that is almost identical to the ones used for real radio-controlled aircraft that plug into the computer through a USB port, and a set of CDs / DVDs to install the program.

Testimonials from many people indicate the number and severity of crashes are reduced by spending time on the simulator prior to flying the radio-controlled aircraft. Additionally, most simulators have many different radio-controlled aircraft included, which allows the pilot to experiment with various aircraft types.



Popular radio-controlled aircraft simulators include:

- RealFlight (Knife Edge Software), and
- FS One (Hangar 9).

ACTIVITY

OBJECTIVE

The objective of this activity is to have the cadets fly a radio-controlled aircraft.

RESOURCES



If an aircraft has to be constructed before flying, complete by:

- setting up a desk or table for each cadet (or group of cadets);
- placing the required construction and / or assembly tools and materials on the tables;
- showing a completed model aircraft to the cadets;
- describing the parts and components of the model aircraft to the cadets; and
- having the cadets construct and / or assemble the model aircraft IAW the plans and / or instructions.

- Radio-controlled aircraft,
- Starting equipment,
- Fuel / batteries,
- Battery charger, and
- Transmitter.

ACTIVITY LAYOUT

Large indoor area (eg, gymnasium or drill hall) or a large outdoor area for flying a radio-controlled aircraft IAW regulations and safety guidelines set out by Model Aeronautics Association of Canada (MAAC).

ACTIVITY INSTRUCTIONS

1. Demonstrate to the cadets how to fly the radio-controlled aircraft to include:
 - a. taking off;
 - b. flying a circuit; and
 - c. landing.
2. Have the cadets fly the radio-controlled aircraft IAW the plans and / or the instructions.

SAFETY

Assistant instructors will monitor the cadets to ensure they are following the instructor's directions and using all equipment safely.



All radio-controlled aircraft activities shall be conducted IAW the regulations and safety guidelines set out by MAAC.

Flying a radio-controlled aircraft should not be attempted without assistance from an experienced radio-controlled aircraft pilot. A list of MAAC sanctioned clubs can be found at http://www.maac.ca/clubs/maac_clubs_map.php.

CONFIRMATION OF TEACHING POINT 1

The cadets' participation in this activity will serve as the confirmation of this TP.

END OF LESSON CONFIRMATION

The cadets' participation in flying a radio-controlled aircraft will serve as the confirmation of this lesson.

CONCLUSION**HOMEWORK / READING / PRACTICE**

Nil.

METHOD OF EVALUATION

Nil.

CLOSING STATEMENT

Flying a radio-controlled aircraft is a fun and challenging way to apply the principles of flight.

INSTRUCTOR NOTES / REMARKS

It is recommended that the three periods required for this EO be scheduled consecutively.

The radio-controlled aircraft can be flown individually or in small groups of two to four cadets.

Assistant instructors are required for this lesson.

Suitable model aircraft may be chosen from the following:

- Blade CX2 / CX3 (radio-controlled electric helicopter),
- Blade MCX (radio-controlled electric helicopter),
- SPAD Debonair (radio-controlled airplane),
- Alpha 40 DSM2 RTF (radio-controlled airplane),
- Vapor Bind-N-Fly / RTF (radio-controlled airplane), and / or
- an alternate choice (or choices) selected by the squadron.

The helicopter being selected should have the counter-rotating rotor system with a 2.4 GHz radio transmitter.

Radio-controlled aircraft simulators such as RealFlight (Knife Edge Software) or FS One (Hangar 9) that run on a personal computer can also be used.

REFERENCES

C3-303 *Model Aeronautics Association of Canada Safety Code*. (2008). Retrieved February 5, 2009, from http://www.maac.ca/docs/2007/maac_safety_code_v008sept30_08_english.pdf